

THE CENTER FOR ENERGY SYSTEMS RESEARCH

TENNESSEE TECHNOLOGICAL UNIVERSITY

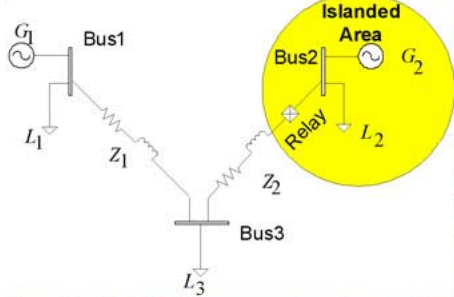

MICROGRID TESTBED

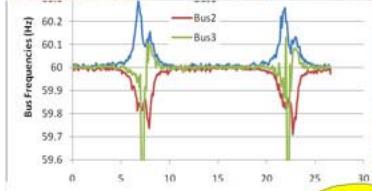
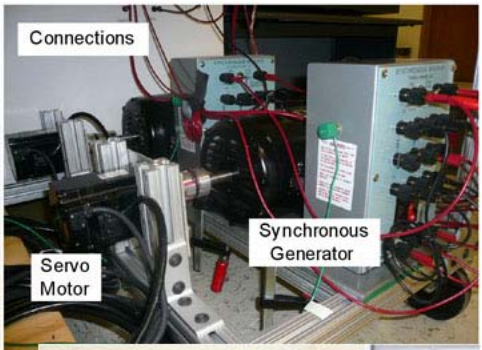
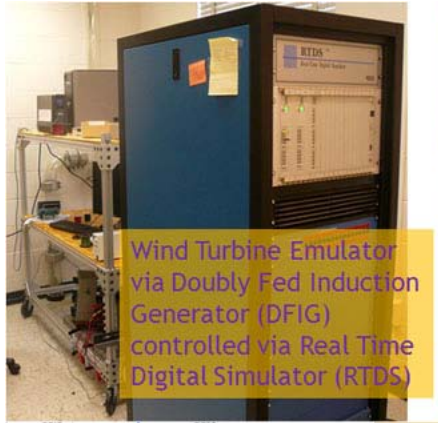
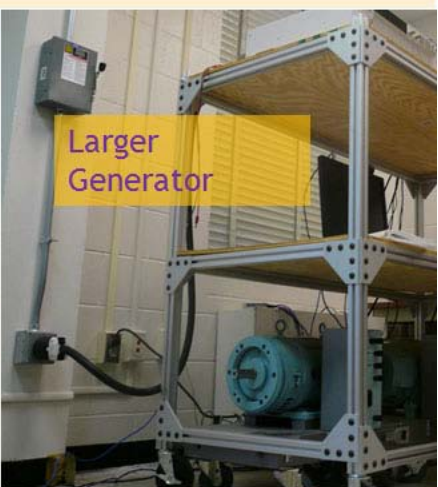
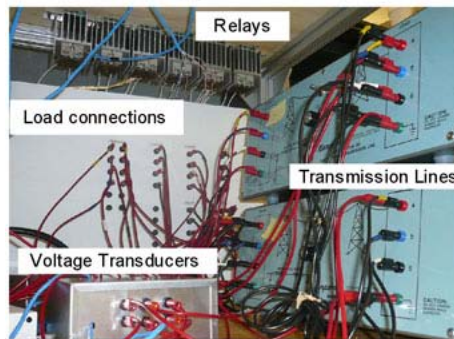

ANNUAL REPORT
FISCAL YEAR
2010 – 2011

Annual Report for Fiscal Year

JULY 1, 2010 – JUNE 30, 2011

Subramaniam Deivanayagam, Interim Director

www.tntech.edu/cesr

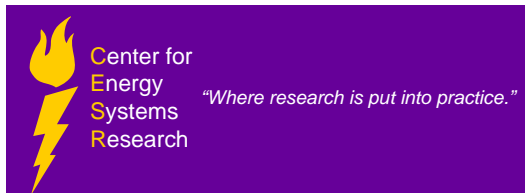

Center for Energy Systems Research

1020 Stadium Drive

Prescott Hall 414

Campus Box 5032

Cookeville, TN 38505

(931) 372-3615

cesr@tntech.edu

www.cesr.tntech.edu/

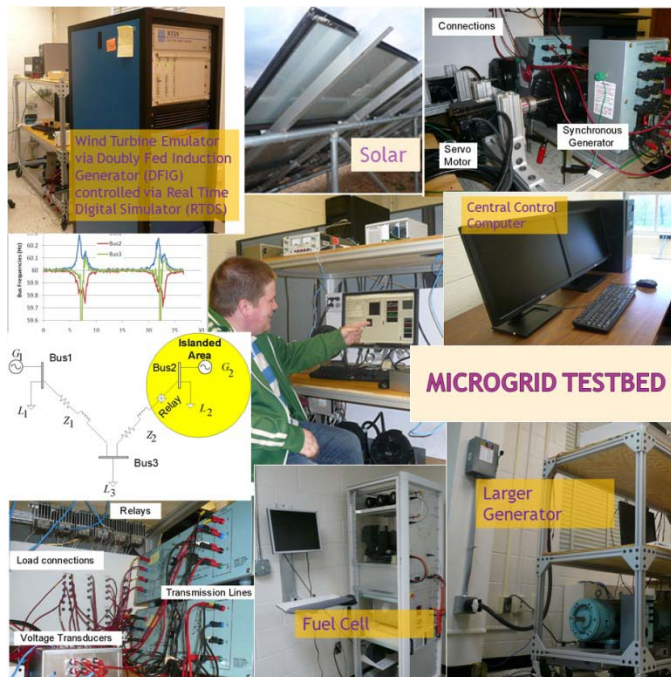

Cover Description: A Laboratory sized power Grid (LabGrid) Microgrid Test bed Undergraduate student Steven Corum running LabGrid's LabView control program.

The Center's mission statement summarizes its overall purpose:
To advance and apply scientific and engineering knowledge associated with energy systems and in particular with electric power while supporting the instructional program of Tennessee Technological University (TTU) in academic areas associated with energy systems.

TABLE OF CONTENTS

PROGRAMMATIC REPORT

CESR MISSION	1
MESSAGE FROM THE DIRECTOR.....	3
RESEARCH AREAS	5
CESR RESEARCH FUNDING 1985 THRU 2011	7
CENTER FOR ENERGY SYSTEMS RESEARCH HIGHLIGHTS	9
FACULTY AWARDS AND ACCOMPLISHMENTS 2010–2011	13
STUDENT ACCOMPLISHMENTS AND AWARDS 2010–2011	15
STUDENT TRAVEL TO CONFERENCES	16
CONFERENCES ATTENDED BY FACULTY AND SUPPORT STAFF	17

PLANS FOR 2011-2012

PLANS FOR 2011-2012.....	21
--------------------------	----

SUPPORTING MATERIALS

SUPPORT STAFF	SM-1	25
FACULTY PARTICIPATION	SM-2	27
CONTRACT AND GRANT AWARDS	SM-3	30
STATUS OF PROPOSALS	SM-4	37
STATUS OF PENDING PROPOSALS	SM-5	40
PUBLICATIONS	SM-6	45
BOOK / CHAPTER PUBLICATIONS	51
INVITED PARTICIPATION	SM-7	52
PROFESSIONAL SERVICE	SM-8	53
VISITORS	SM-9	58
SEMINAR SERIES	SM-10	59
CESR GRADUATES	SM-11	60
GRADUATE STUDENT SUPPORT	SM-12	63
HOURLY STUDENT PERSONNEL	SM-13	65

BUDGET MATERIALS

ACTUAL, PROPOSED, AND REQUESTED BUDGET	SCHEDULE 7	69
SCHEDULE 13A	ACTUAL PERSONNEL	71
SCHEDULE 13B	PROPOSED PERSONNEL	72
SCHEDULE 13C	REQUESTED PERSONNEL	73
SCHEDULE 14A	2010-2011 PURCHASED EQUIPMENT	74
SCHEDULE 14B	PROPOSED EQUIPMENT	75
SCHEDULE 14C	REQUESTED EQUIPMENT	76
SCHEDULE 15A	BASE SUPPORT AND NON-EQUIPMENT MATCHING	77
SCHEDULE 15B	PROPOSED BASE SUPPORT AND NON-EQUIPMENT MATCHING	80
SCHEDULE 15C	BASE SUPPORT AND NON-EQUIPMENT MATCHING	81

PROGRAMMATIC REPORT



Dr. Steve Canfield's EIME project photos — **Photo 1:** Activity Board – The project consists of a metal frame with two sections. Each section has three activity boxes designed to stimulate the senses of special needs children in order to improve their motor skills and to provide positive reinforcement when performing common tasks correctly. **Photo 2 and 3:** Playground – The playground was designed to adhere to the special needs of the child as well as meet safety standards and be easily disassembled. **Photo 4** – For this project, the students were given the task of designing a “scooter board” that will be used by preschool aged children with arm and joint functionality problems.

CESR MISSION

The Center for Energy Systems Research (CESR) was established to advance and apply scientific and engineering knowledge associated with energy systems and in particular with electric power while supporting the instructional program of Tennessee Technological University (TTU) in academic areas associated with energy systems.

Research efforts, both theoretical and experimental, are focused on solving current and anticipated problems associated with energy systems. Special emphasis is given to the needs of the electric power industry.

VISION

The Center's vision is to enhance research and education in support of its mission. The Center's vision is to pursue advanced and applied research to enhance knowledge in currently needed and emerging technical areas of energy systems. The Center also has major interests in dissemination of knowledge and enhancing education in energy systems.

The Center draws upon the expertise from the faculty in the College of Engineering as well as from other faculty on campus. Participating faculty and faculty associates represent Chemical Engineering, Civil and Environmental Engineering, Electrical and Computer Engineering, Mathematics, Mechanical Engineering and Manufacturing and Industrial Technology.

HISTORY

The Center for Electric Power was established in 1985 in the College of Engineering at Tennessee Technological University by the State of Tennessee. The name of the Center has now been changed to Center for Energy Systems Research in order to reflect the broadening of activities. Over the years several funding agencies have sponsored projects. These include 20 major electric utilities, EPRI and federal agencies such as DOE, NASA, NSF, and ONR and state agencies such as TDOT and State Department of Education—Division of Special Education. In addition, several other industries have sponsored research projects.

CESR operates within the TTU System. Support in the form of travel money and graduate student support is provided to faculty members to encourage them to submit research proposals to external agencies through the Center. Where needed, support for marketing research concepts is also provided.

In addition, CESR provides services of an R&D Engineer, Post-Doctoral Research Associates, Network Manager, Financial Analyst, Grants Fiscal Clerk, and Secretary in support of the various research activities performed by faculty and students.

PROGRAMMATIC REPORT

MESSAGE FROM THE DIRECTOR

YEAR IN REVIEW

The academic year 2010-2011 has been a very busy year for the Center for Energy Systems Research personnel. Dr. Sastry Munukutla, resigned as CESR's Director at the end of July 2010 and became a fulltime faculty in the Mechanical Engineering Department. Dr. Subramaniam Deivanayagam, Associate Dean of Research and Graduate Studies, was appointed as the Interim Director of CESR on additional responsibility. Dr. Wenzhong Gao, Assistant Professor, resigned his position in CESR effective August 2010, and moved to the University of Denver.

The two year Smart Grid Research project, funded by DOE, is nearing completion with Dr. Sastry Munukutla as the P.I. The objective is to conduct state-of-the art research in Smart Grid Applications for electric power systems.

Dr. Joseph Ojo's three year research project from the Office of Naval Research to develop new multi-level converters for electric motor drives with many phases will be completed at the end of September. Some of the research accomplished includes the following: (1)

Developed the theory of the multiphase induction motor drives; (2) Designed, built and tested a three-level five phase converter with an innovative modulation scheme; (3) Designed and simulated the control of motor drive under vector control.

Dr. Satish Mahajan's project with Buswell Energy to develop a wire core transformer has been ongoing in 2010-11 and is nearing completion.

Dr. Steve Idem had two research projects with CESR in the fiscal year; one project with ASHRAE, "Laboratory Testing of Flat Oval Duct Fittings to Determine Loss Coefficients", and the second project with Spiral Duct Manufacturers Association (SPIDA), "Laboratory Testing of Increased Area (Pressed) Saddle Tap Tees to Determine Loss Coefficients".

Dr. Stephen Canfield and Dr. Sheikh Ghafoor received funding for a three year research project "Enhancing the Programming Experience for Engineering Students through Hands-On Integrated Computer Experiences" from the National Science Foundation (NSF) to refine and extend a model in which students begin learning programming in an environment that matches their notions and allows them to design systems that control the world around them.

Dr. Canfield and Dr. Hwan-Sik Yoon are working on year two of three years of the EIME project with the Tennessee State Department of Education-Division of Special Education. Dr. Canfield also has a project with Robotic Technologies of Tennessee (RTT) to develop a remote climbing robot for automating welding process on the shipbuilding industry.

Dr. Ahmed Elsaywy received approval of a research project from the National Shipbuilding Research Program for \$24,011 for 1.5 years to address the state-of-art in mechanized welding.

The Tennessee Department of Transportation (TDOT) awarded research projects to Dr. L.K. Crouch for TDOT Class D Portland Cement Concrete and a two year contract to research higher volume Fly Ash PCC for Sustainability and Performance. TDOT also awarded a two year research project to Dr. Xiaoming Sharon Huo to study Tennessee Highway Bridge Design.

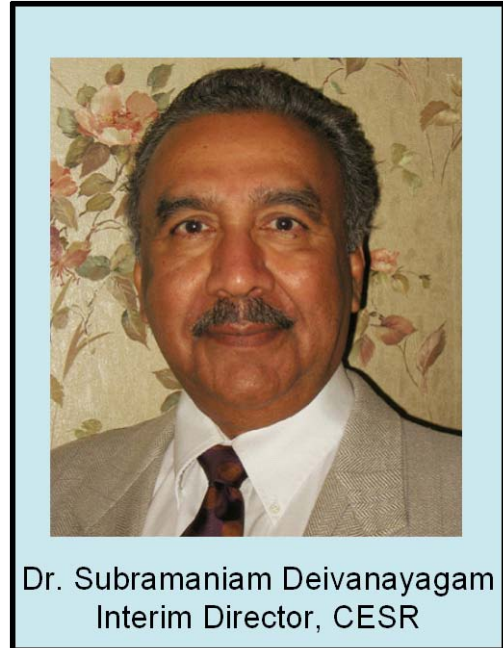

Dr. Daniel Badoe received a 2.5 year research project from the University of Tennessee-Knoxville (Funded by TDOT) for the Development of Tennessee Travel Demand Model Users' Model Group to improve on the travel demand forecasting capabilities of transportation planning agencies within the state of Tennessee.

Dr. Steven Click completed his second year of a three year project with TDOT for evaluation of traffic signal based interchange treatments.

Dr. Sabine Le Borne has been selected for a one year appointment as the Program Director for the Computational Mathematics Program, Division of Mathematical Sciences, Directorate for Mathematical and Physical Sciences at the National Science Foundation. She will direct the Computational Math Program's merit review process for awarding grants.

Dr. Benjamin Mohr was awarded a three year project from the National Science Foundation to investigate the nano-and micro-scale mechanisms of late age ettringite formation and how these mechanisms relate to macro-scale expansion in concrete materials.

Dr. Glenn Cunningham and Dr. Joseph Ojo were appointed as TVA Chairs for a three year term. They are entering year two of their appointment. The endowed chair positions were created to support teaching and research in electrical and mechanical engineering.

Dr. Ismail Fidan, Tennessee Tech University professor of manufacturing and industrial technology, is the recipient of the 2011 Brown-Henderson Award. The Brown-Henderson award honors outstanding performance in teaching and research or service and carries the names of TTU College of Engineering Dean Emeritus James Seay Brown and James Henderson, the college's first dean.

Dr. Jane Liu and Dr. John Peddieson were awarded a two year contract by United Launch Alliance to research interface simulation techniques pertinent to moisture diffusion in composites, biaxial stress and strain testing of Rohacell with DIC techniques, and nonlinear behavior of Rohacell.

Dr. Jie Cui is the principal investigator for the NSF Career project for Dr. Wenzhong as Dr. Gao took a position at the University of Denver. This project is in year two of the five-year project.

Dr. Ali Alouani received funding from Merritt Island Holdings, LLC, for a project on Using Solar Power for Chevy Volts Commuters.

PROGRAMMATIC REPORT

RESEARCH AREAS

Research contract and grant awards activated from July 1, 2010 thru June 30, 2011 total \$896,555. The distribution among the Center for Energy Systems Research (CESR) areas of research is shown in the following table.

Research Area	Activated Amount
Power Systems Performance Improvement	\$156,322
Environmental Issues and Energy Conservation	\$18,250
Advanced Technologies	\$690,287
Testing and Service Contracts	\$11,266
Miscellaneous Contracts	\$20,430
Total Activated Amount	\$896,555

CESR continues to enjoy a broad base of support. The funding categories for 1985 thru 2011 as illustrated in Figure 1 are: in-state utilities, 14.24 percent; out-of-state utilities 7.75 percent; state and local agencies, 11.20 percent; federal government, 51.91 percent; other, 14.90 percent. The "other" category includes a variety of national and international industries, universities and professional societies. Through June 2011, the cumulative research funding of the Center is \$23,355,645. State appropriations are compared to matching, on an annual basis, in Figure 2. Matching is divided into contracts and grants (without indirect costs); equipment; and all other items such as software, books and reports, and funding for faculty and student exchange programs. The 26-year match of about \$23.40 million represents 100.83 percent of the state appropriations of \$23.10 million. Indirect costs of approximately \$4.20 million have also been received. The 2010-2011 match is \$718,735 and the state appropriation is \$922,800. A list of the projects conducted under the major research areas is given in SM-3 in this report.

CESR RESEARCH FUNDING 1985 THRU 2011

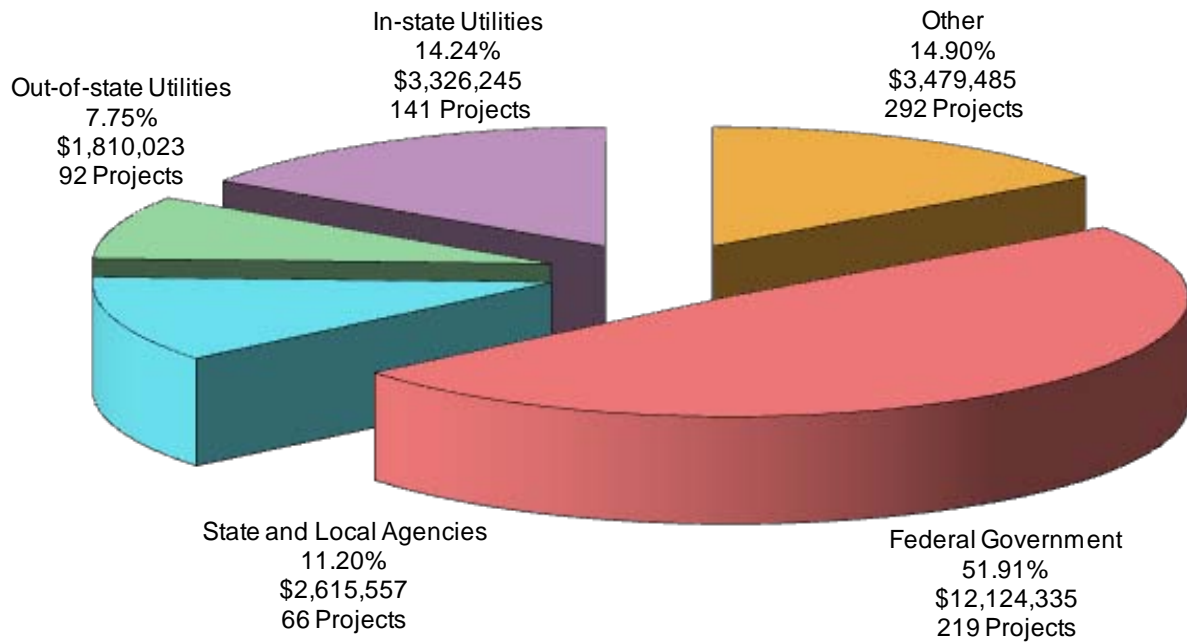

Figure 1: Types of Research Funding (Total \$23,355,645)

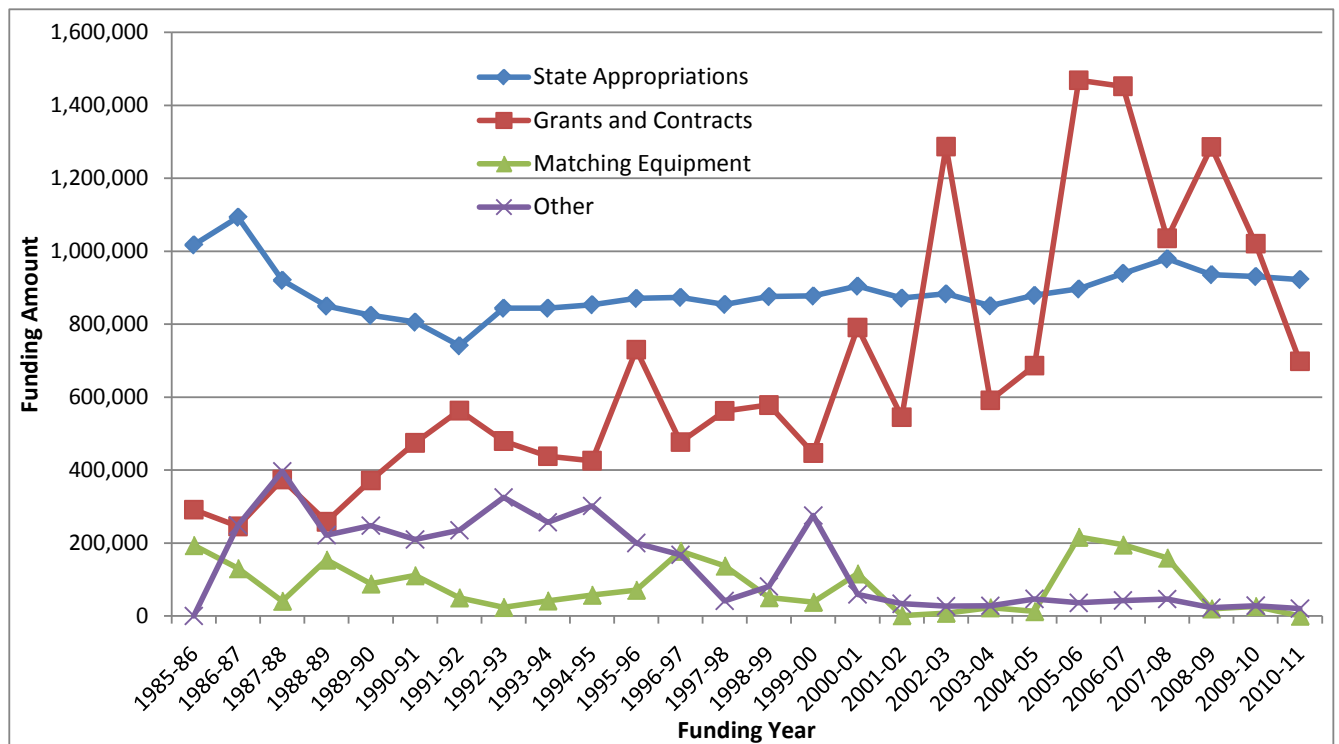
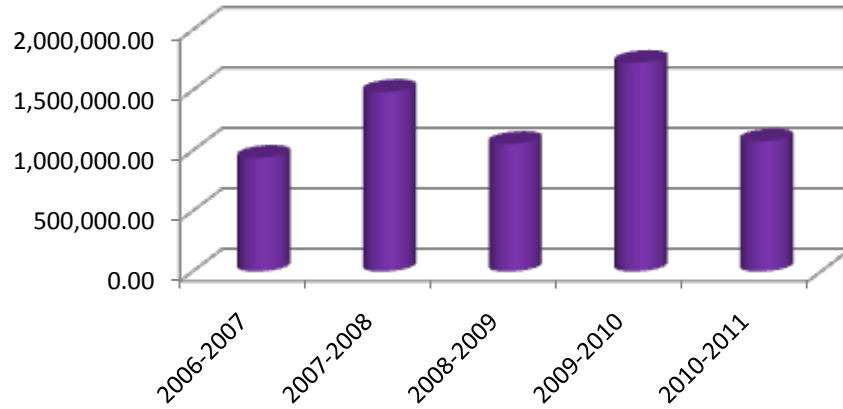
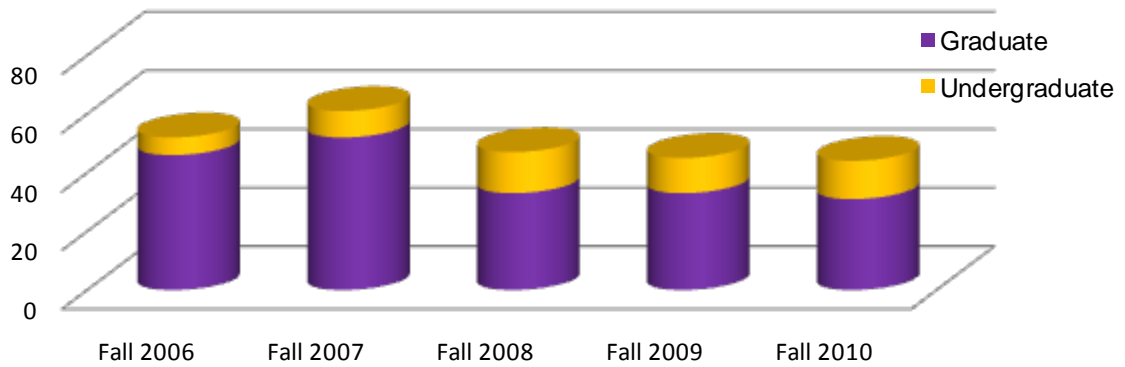

Figure 2: Historical State Appropriations and Matching

Center for Energy Systems Research Activations in dollars



Center for Energy Systems Research Fall (Number of Students Supported Financially)



CENTER FOR ENERGY SYSTEMS RESEARCH HIGHLIGHTS

Professors and graduate students performing research with the Center for Energy Systems Research (CESR) can draw upon the many labs and resources of the university, college, and various departments. In addition to these facilities the center has several resources that may prove useful for new research endeavors.

New Research Initiatives

In order to make the most of precious resources, CESR looks to groups of professors and staff to band together in common research areas so that resources spent on basic development work can have the most benefit for all. Teaching, research, and external collaborative efforts will all benefit from this synergistic environment.

The TTU "Smart Grid Group" is one such group of researchers who have banded together to build a microgrid "test bed". Research in the areas of electric power, smart grid, power electronics, power disturbance mitigation, communications, control, computer programming, and security can all benefit from this common research facility. The inclusion of wind and solar power sources highlights the interest in "green energy" research.

ROBERT CRAVEN

Microgrid Test Bed / CESR and DOE Smartgrid

Microgrid Test Bed CESR and DOE Smartgrid (\$50K and \$20K)

Wind Turbine Emulator via Doubly Fed Induction Generator (DFIG) controlled via Real Time Digital Simulator (RTDS)

Fuel Cell

Time (ms)

Islanded Area

DOE funded LabGrid

Larger Generator

SOLAR

Central Control Computer

Bus1, Bus2, Bus3, G₁, G₂, L₁, L₂, L₃, Z₁, Z₂, Z₃, Relay

Research Areas

- Power electronics
- Disturbance mitigation
- Energy storage
- New sensor development
- Distributed intelligence for sensing and local control
- Data security
- Cognitive radio
- Grid state estimation
- Grid control techniques
- Intelligent load shedding
- Islanding detection, mitigation, and implementation
- Load balancing
- Generator speed correlation with frequency and phase measurements
- Vehicle to Grid (V2G) technologies

DR. SASTRY MUNUKUTLA

Smart Grid Research DOE/ORNL \$415,000, September 1, 2009 – July 31, 2011

Objective: To Conduct state-of-the art research in Smart Grid Applications

Four major areas were selected for investigation: (1) Theoretical and Physical Models for Frequency Study (2) Application of FNET to Smart Grid Research (3) Microgrid Research (4) Cyber Security.

CENTER FOR ENERGY SYSTEMS RESEARCH HIGHLIGHTS (CONTINUED)

DR. SABINE LE BORNE

Algebraic hierarchical matrix preconditioners for two- and three-dimensional saddle point problems – National Science Foundation, DMS-0913017 – \$137,149 / July 1, 2009- June 30, 2012

This project deals with the development, analysis and implementation of novel techniques for the solution of large, sparse linear systems of equations of saddle point type. The recently introduced hierarchical matrix techniques will be further developed as a tool. Five undergraduate students have participated in this work through individual research projects.

DR. AMBAREEN SIRAJ

FNET CYBER SECURITY, August 2009 – July 2011

OBJECTIVES: Identify weaknesses in the existing FNET system and implement measures to protect against the vulnerabilities.

WORK ACCOMPLISHED SO FAR: (1) Identified vulnerabilities present in the existing FNET systems. (2) Conducted an experimental series of attacks to exploit identified vulnerabilities. (3) Proposed to use “chaffing and winnowing” technique for secure FNET communication and showed the feasibility of the technique in this environment. (4) Experimenting with a reputation based trust system to detect compromised or misbehaving sensors.

DR. JOSEPH O. OJO

Multiphase, Multi-Level Induction Motor Drives — Office of Naval Research (ONR), \$537,405 / July 1, 2008 – September 30, 2011

OBJECTIVE: (1) The research is to develop new multi-level converters for electric motor drives with many phases. Multiphase motor drives ensures fault-tolerant and high reliability operation in critical applications.

WORK ACCOMPLISHED SO FAR: (1) Developed the theory of the multiphase induction motor drives. (2) Designed, built and tested a three-level five phase converter with an innovative modulation scheme. (3) Designed and simulated the control of motor drive under vector control.

DR. ALI ALOUANI

Intelligent Synchrophasor Design & Development, \$20,000 / DURATION: 3 YEARS

OBJECTIVES: Design and develop a low cost single phase synchrophasor to be used for smart grid monitoring & control

WORK ACCOMPLISHED SO FAR: First prototype has been developed with data acquisition and communication capability. The device will be presented at the upcoming TTDC.

Future work: Develop the control capability for a single phase synchrophasor this summer of 2011. Start working on the 3 phase system in the fall of 2011.

DR. L. K. CROUCH

TDOT Aggregate-Lime-Fly Ash Stabilized Base Modifications, \$15,552 / January – December 2011

OBJECTIVE: (1) Produce a TDOT 312 Aggregate-Lime-Fly Ash Stabilized Base Course with commercially available materials (Cumberland City Class F fly ash). Measure compressive strength and static modulus of elasticity on 24 laboratory compacted samples. – underway and going well;

(2) Replace Cumberland City Class F fly ash with Colbert fly ash (LOI = 12%, TVA’s worst) on a 1:1 weight basis. Measure compressive strength and static modulus of elasticity on 24 laboratory compacted samples. – underway;

(3) Replace the course portion of TDOT Grading C limestone with commercially-available recycled concrete aggregate. Measure compressive strength and static modulus of elasticity on 24 laboratory compacted samples. – recycled PCC available late Spring;

(4) Produce a Aggregate-Lime-Fly Ash Stabilized Base Course containing both Colbert ash and recycled concrete aggregate substitutions. Measure compressive strength and static modulus of elasticity on 24 laboratory compacted samples.

CENTER FOR ENERGY SYSTEMS RESEARCH HIGHLIGHTS (CONTINUED)

DR. AHMED ELSAWY

Advanced Systems Development of the MRWS: A Remote Climbing Robot for Automating Welding Processes in the Ship Building Industry – NSRP ASE/Advanced Technology Institute (ATI), Robotic Technologies of Tennessee (RTT)

\$24,011 / June 28, 2010 to January 31, 2012

Objectives: (1) Develop technologies that will reduce the cost of building and maintaining ships to the U.S. Navy & improve U.S. shipbuilding technical and business practices and processes.

Accomplishments: (1) Milestone # 2 (09/02/10) Investigation of need for actuator on travel angle;

(2) Milestone #3 (12/15/10) Evaluate control pendant design and provide feedback

(3) Milestone #4 (3/15/11) Determination on interpass cleaning requirements

DR. STEVEN CLICK, PE

Tennessee Department of Transportation (TDOT)

\$200,000 / 3-Year Project

The purpose of this research is to field-test one traditional and two innovative traffic signal treatments designed to improve vehicular capacity at narrow (2-lane) over- and underpasses associated with interstate interchanges. The potential benefits include postponement of expensive construction projects to widen or replace existing facilities which are structurally sound.

WORK ACCOMPLISHED SO FAR: The stakeholder kick-off meeting is complete, data collection equipment is being tested, and required interchange modifications are being planned.

DR. DANIEL BADOE, PI ON SUBCONTRACT TO TTU

Tennessee Model Users Group (TNMUG), Tennessee Department of Transportation

\$27,750 / Duration: 3 years

Objective: To improve on travel demand forecasting capabilities of transportation planning agencies within the state of Tennessee through limited research on modeling issues of interest to the group, software training workshops, and technical presentations

Work accomplished so far:

Undertaken study on transportation data collection; given a technical presentation at quarterly meeting of TNMUG

DR. BEN MOHR, PI,

TRANSPORT KINETICS OF INTERNAL CURING WATER IN HIGH PERFORMANCE CONCRETES –National Science Foundation CMMI-00556015, \$220,767, August 2006 – July 2010

The research team has also developed a system for sample rotation at early ages. Rotation of the corrugated samples is important to eliminate bleeding. Reabsorption of bleed water has been shown to cause initial expansion of some samples at early ages, possibly underestimating the amount of autogenous shrinkage at later ages.

In collaboration with NIST, a computational model has been developed to assess the sphere of influence around internal curing fibers. This model had previously been developed for 'spherical' lightweight aggregates, but is now modified for 'ellipsoidal' fibers.

Time-Domain Reflectometry (TDR) has been utilized to investigate changes in the amounts of free and bound water in the samples beginning as early as reasonably possible until approximately 7 days. The water contained in the control pastes will gradually evolve from free to bound water over time. It is anticipated that the addition of water held in the internal curing materials will delay the transition from free to bound water and ultimately increase the amount of bound water in the sample. For the first anticipated result, the time of delay will lead to an improved understanding of the kinetics of moisture release and transport from the internal curing materials to the hydrating cement paste. As for the latter result, this would be a direct indication of an increase of the degree of hydration (amount of reaction).

CENTER FOR ENERGY SYSTEMS RESEARCH HIGHLIGHTS (CONTINUED)

DRS. JANE LIU AND JOHN PEDDIESON, PI

MODELING OF MOISTURE DIFFUSION IN COMPOSITES – United Launch Alliance

\$73,100 / April 2009 – August 2011

- 1) Modeling of Moisture Diffusion in Composites
- 2) Biaxial Stress Testing of Rohacell
- 3) Derivation of Equations for Biaxial Stress Test
- 4) Evaluation of Low-Cost Digital Image Correlation for Strength Tests
- 5) Large Strain Behavior of Rohacell

AMOUNT, DURATION, OBJECTIVES: This set of research studies funded by ULA from 2009 to 2011 with a total amount \$73,100 involves mainly interface simulation techniques pertinent to moisture diffusion in composites, biaxial stress and strain testing of Rohacell with DIC techniques, and nonlinear behavior of Rohacell.

WORK ACCOMPLISHED SO FAR: 1 - 4 are finished and 5 is expected to finish by the end of August, 2011.

DR. HOLLY STRETZ, PI

Nanoparticle Barrier Layers

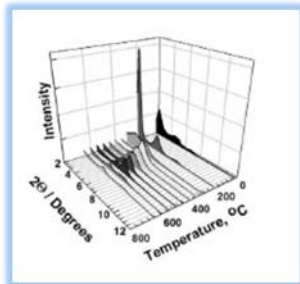

Objectives: Self-assembled nanoparticle barrier layers must (1) form a stable morphology at high temperature, (2) retard heat and mass transport and (3) exhibit toughness at high temperature under stress. This project seeks fundamental structure-property relations. Hypothesis: Percolation of morphology leads to high temperature barrier toughness.

Project milestones: (1) Find “benchmark” morphologies which produce a change in transfer properties. Done. (2) Review literature critically for evidence of heat transfer effects in nanomaterials. Done. (3) Compare structural integrity of various nanocomposites at high temperature. Resolve if percolation is necessary in order to exhibit tough or responsive properties. Sample preparation/testing in progress. (4) Resolve if polymer crystallinity interferes with nano-domain percolation. Lit review in progress.

Work accomplished so far: (1) Fox, B., Ambuken, P., Stretz, H. A., Payzant, A., Meisner, R., “Organo-montmorillonite barrier layers formed by combustion: Nanostructure and permeability,” *Applied Clay Science*, **49**, (2010) 213-223. (2) Tant, M., Stretz, H. A., Ambuken, P., “Polymeric Composites: Heat Transfer,” *Encyclopedia of Composites*, Wiley & Sons, submitted 04- 2011. (3) Training TA Instruments AR 550, sample prep (received from J. Koo, UTexas-Austin).

DR. STEPHEN CANFIELD, PI

TN Department of Special Education – Early Intervention and Mechanical Engineering (EIME): Merging Early Intervention / Mechanical Engineering

\$35,000 yearly / July 31, 2005 – June 30, 2012

Objectives: Implement Real-world Design problems in the ME UG curriculum
Develop innovative assistive technology devices for children with disabilities

Accomplishments: 600+ engineering students involved in projects
125+ children with special needs served

FACULTY AWARDS AND ACCOMPLISHMENTS

2010–2011

Dr. Daniel Badoe – was one of the recipients of the 2011 Outstanding Faculty Awards in Teaching. The awards are presented annually to honor faculty members for service and excellence both in and out of the classroom.



Dr. Stephen Canfield was chosen to receive the 2010 Rep. Harold Love Outstanding Community Service Award presented by the Tennessee Higher Education Commission for his dedication to the Early Intervention and Mechanical Engineering (EIME) project at TTU.



Dr. Ismail Fidan, Tennessee Tech University professor of manufacturing and industrial technology, is the recipient of the 2011 Brown-Henderson Award. The Brown-Henderson award honors outstanding performance in teaching and research or service and carries the names of TTU College of Engineering Dean Emeritus James Seay Brown and James Henderson, the college's first dean.



Dr. Ahmed Kamal – earned NIH/NSF two fellowship in biomanufacturing. The first fellowship Kamal earned placed him at a workshop focusing on the informatics for data and resource discovery in addiction research held at NIH's Neuroscience Center in Rockville, MD.

The second fellowship, awarded by Maricopa Advance Technology Education Center and NSF, led Kamal to dual events: the Critical Issues and Best Practices Forum and the High Impact Technology Exchange Conference held in Orlando, Fla., in July 2010.



Dr. Sabine Le Borne – Has been selected for a one year appointment as the Program Director for the Computational Mathematics Program, Division of Mathematical Sciences, Directorate for Mathematical and Physical Sciences at the National Science Foundation.

FACULY AWARDS AND ACCOMPLISHMENTS (CONTINUED)

2010–2011

Dr. Benjamin Mohr – was awarded the 2011 Kinslow Award for Best Paper for his extensive research in concrete durability. The Kinslow Award is given annually for the best research paper written by a TTU engineering faculty member and published in a refereed professional journal.

Dr. Mohr also received NSF support to research concrete durability of concrete at a nano-scale level and study the mechanisms of degradation that make it crack.



Dr. Joseph Ojo – was selected as Fellow IEEE. IEEE Fellow is a distinction reserved for select IEEE members whose extraordinary accomplishments in any of the IEEE fields of interest are deemed fitting of this prestigious grade elevation.

Dr. Holly Stretz – received the Outstanding New Faculty Research Award from the Southeastern Section of the American Society for Engineering Education (ASEE) for her research in the transport of gold nanoparticles. The ASEE award recognizes a faculty member who has less than six years of teaching/research experience and has demonstrated excellence in both teaching and research.



STUDENT ACCOMPLISHMENTS AND AWARDS

2010–2011

Student Research Day at Tennessee Technological University is an event designed to showcase in a poster format the research of students. Several CESR students showcased their research posters in April 2011. Each participant received a certificate of appreciation and a bronze medallion. CESR Graduate Students **Sosthenes Karugaba, Arash Jamehbozorg, Lazarus Uzoечи, Seyed Nasser Keshmiri, Uwakwe Chukwu, Chayanon Sontidpanya, Melaku Mihret, and Ganapathy Kumar.**



Photo courtesy of Arash Jamehbozorg

CESR Graduate Student, **Chayanon Sontidpanya**, ECE Masters student, received the “Best Poster Award” at TTU’s 2011 Student Research Day.
(photo courtesy of Chayanon Sontidpanya)

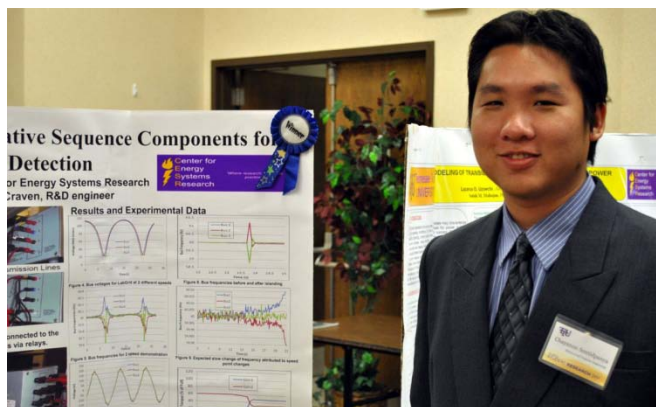

Samantha Jeffries, a Civil Engineering Student, was selected to receive (the Samuel Fletcher Tapman ASCE) one of 12 national scholarships from the American Society of Civil Engineers to go toward her education because of her involvement in the society’s student chapter at TTU.



Programmatic Report 15

STUDENT TRAVEL TO CONFERENCES

Seyed Nasser Keshmiri (Wenzhong Gao, Advisor) presented paper “Multi-Objective Stochastic Economic Dispatch”, at North American Power Symposium (NAPS) at the University of Texas, Arlington, September 2010.

Tabrizi M. Aghazadeh (Wenzhong Gao, Advisor) presented paper “PMU-Based Multi-Input SVC Supplementary Controller for Damping Inter-area Oscillation”, at North American Power Symposium (NAPS) at the University of Texas, Arlington, September 2010.

Mehriar Aghazadeh Tabrizi (Ghadir Radman, Advisor) presented paper, “Micro Grid voltage profile improvement using Micro Grid Voltage Controller,” submitted to 42th North American Power Symposium (NAPS 2011), USA.

Arash Jamehbozorg (Wenzhong Gao, Advisor) presented paper “A New Controller Design for a Synchronous Generator-Based Variable-Speed Wind Turbine”, at North American Power Symposium (NAPS) at the University of Texas, Arlington, September 2010.

Bijaya Pokharel (Wenzhong Gao, Advisor) presented paper “Mitigation of Disturbances in DFIG-based Wind Farm Connected to Weak Distribution System Using STATCOM”, at North American Power Symposium (NAPS) at the University of Texas, Arlington, September 2010.

Sosthenes Karugaba (Joseph Ojo, Advisor) presented paper “Modulation Schemes for Five-Phase to Three-Phase AC-AC Matrix Converters,” in the Conference Record of IEEE Energy Conversion Congress and Expo (ECCE2010), September 12-16, 2010, Atlanta, Georgia.

Melaku Mihret (Joseph Ojo, Advisor) presented paper at ECCE 2010 IEEE Energy Conversion Congress & Expo in Atlanta, Georgia, September 2010. Melaku Mihret, Meharegzi Abreham, Olorunfemi Ojo, Sosthenes Karugaba, “Modulation Schemes for Five-Phase to Three-Phase AC-AC Matrix Converters,” in the Conference Record of IEEE Energy Conversion Congress and Expo (ECCE2010), September 12-16, 2010, Atlanta, Georgia.

Sulayman Usman (Ali Alouani, Advisor) Presentation at project related meeting with TVA in Chattanooga, Tennessee, January 2011.

Meharegzi Abreham (Joseph Ojo, Advisor) presented paper at ECCE 2010 IEEE Energy Conversion Congress & Expo in Atlanta, Georgia, September 2010. Melaku Mihret, Meharegzi Abreham, Olorunfemi Ojo, Sosthenes Karugaba, “Modulation Schemes for Five-Phase to Three-Phase AC-AC Matrix Converters,” in the Conference Record of IEEE Energy Conversion Congress and Expo (ECCE2010), September 12-16, 2010, Atlanta, Georgia.

Amrit Gautam (Joseph Ojo, Advisor) presentation, “Modeling of Nine Phase Interior Permanent Magnet Machine Including Harmonic Effects,” at IEEE International Electric Machines and Drives Conference (IEMDC 2011) in Niagara Falls, Canada, May 2011.

Joseph Layton McDaniel (Ambareen Siraj, Advisor) presented a paper at IASTED International Conference on Wireless Communications in Vancouver, BC, Canada, June 2011.

Hossein Karimi-Davijani (Joseph Ojo, Advisor) presented at PES Innovative Smart Grid Technologies Conference in Anaheim, California, January 2011.

Lindsay Bryant (Benjamin Mohr, Advisor) attended American Concrete Institute (ACI) Fall 2010 Convention in Pittsburgh, Pennsylvania, October 2010

CONFERENCES ATTENDED BY FACULTY AND SUPPORT STAFF

Ali Alouani

Presentation at TVA in Chattanooga, Tennessee, January 2011.

Daniel Badoe

Project meeting, Tennessee Model Users' Group Meeting, Mount Juliet, Tennessee, March 2011.

Stephen Canfield

Presentation 2011 NSF Grantees Principal Investigators' Conference, TUES program, Washington, DC, January, 2011.

Steven Click

Attended Traffic Signal Systems Committee Summer Meeting at the University of Idaho, July 2010.

Robert Craven

Presentation at IEEE SoutheastCon 2011, Nashville, Tennessee, March 2011.

L.K. Crouch

Presentation at Nashville TDOT Materials for tests and research update, Nashville, Tennessee, January 2011.

Presentation at Nashville TDOT for research update, Nashville, Tennessee, February 2011.

Jie Cui

Attended 2010 ASME Mechanical Engineering Congress and Exposition as presenter in Vancouver, Canada, November 2010.

Ismail Fidan

Attended 2011 NSF CCLI Conference in Washington, DC, January 2011.

(David) Wenzhong Gao

Presented Technical Paper at 2010 IEEE PES General Meeting in Minneapolis, Minnesota, July 2010.

Stephen Idem

Presentation at ASHRAE 2011 Winter Meeting in Las Vegas, Nevada, January 2011.

Sabine Le Borne

Attended workshop on "Fast solvers for partial differential equations", Mathematisches Forschungsinstitut Oberwolfach, in Kiel, Germany May 2011 as invited participant.

Attended the SIAM Computational Science and Engineering Conference in Reno, NV, Feb 28-Mar 4, 2011 as invited participant.

Presented poster at the Workshop on "Numerical Solutions of Partial Differential Equations: Fast Solution Techniques", Institute for Mathematics and Its Applications (IMA) at the University of Minnesota, MN, November 29 - Dec. 3, 2010.

Satish Mahajan

Presentation at North American Power Symposium (NAPS) in Arlington, Texas, September 2010

Attended IEEE Transformers' Committee Meeting, "Estimation of Loss of Life of a 69 kV Current Transformer", Toronto, Canada, October 2010.

Benjamin Mohr

Attended American Concrete Institute (ACI) Fall 2010 Convention in Pittsburgh, Pennsylvania, October 2010.

Attended NSF CMMI Research and Innovation Conference 2011 in Atlanta, Georgia, January 2011.

Sastry Munukutla

Attended project related meeting with Goodrich in Des Moines, Iowa, July 2010

Attended Power-Gen Asia Conference as presenter in Singapore, November 2010

Attended (Energy, Exergy & Environment) INEEEE Conference in Venice, as presenter, Italy March 2011

Presenter at Council of Industrial Boiler Owners Fluidized Bed XXIV Conference 2011 in Hershey, Pennsylvania, May 2011.

CONFERENCES ATTENDED BY FACULTY AND SUPPORT STAFF

Joseph O. Ojo

Invited presenter at IEEE International Symposium on Industrial Electronics in Bari, Italy, July 2010.

Presentation at IEEE International Electric Machines and Drives Conference (IEMDC 2011) in Niagara Falls, Canada, May 2011.

Presentation at 20th IEEE International Symposium on Industrial Electronics at Gdansk University of Technology in Gdansk, Poland, June 2011.

Invited presenter at IEEE PES General Meeting in Minneapolis, Minnesota, July 2010.

Presenter at ECCE 2010 IEEE Energy Conversion Congress and Expo in Atlanta, Georgia, September 2010.

Transmission Reliability Peer Review Conference as presenter, Alexandria, Virginia, October 2010.

Mahesh Panchagnula

Attended project related meeting with Goodrich in Des Moines, Iowa, July 2010.

John Peddieson

Attended project related meeting with Goodrich in Des Moines, Iowa, July 2010.

Ghadir Radman

Attended Clean Technology Conference and Expo, Anaheim, California, June 2010.

Transmission Reliability Peer Review Conference in Alexandria, Virginia, October 2010.

Holly Stretz

Attended Seminar for training on the Transmission Electron Microscope at MIMIC Facility at MTSU, Murfreesboro, Tennessee, August 2010.

FUTURE PLANS



Dr. L.K. Crouch's Masters student Sarah (Deese) Dillon
(Research for CESR)

Produce a TDOT 312 Aggregate-Lime-Fly Ash Stabilized Base Course with commercially available materials (Cumberland City Class F fly ash). Replace Cumberland City Class F fly ash with Colbert fly ash (LOI = 8%, TVA's worst) on a 1:1 weight basis. Compare compressive strength and static modulus of elasticity on laboratory compacted samples.

(Photo courtesy of Dr. Crouch)

PLANS FOR 2011-2012

The Center for Energy Systems Research (CESR) will continue to create interdisciplinary research teams to meet the needs of the Center's sponsors. New and established engineering faculty and faculty associates from outside the College of Engineering will continue to participate in research. Also, collaboration with other universities will be continued. In addition, education and research throughout the world in the area of electric power will be enhanced by involving graduate students from the United States and abroad.

CESR Goals

To contribute to ongoing research related to energy systems and be recognized as a national leader.

To contribute to ongoing university instructional and research activities and educational outreach activities at the highest level possible.

To contribute to technology transfer and thereby improve the quality of life of citizens of Tennessee and the U.S.A.

To increase externally funded research through the Center for Energy Systems Research.

To stimulate activities that increase external funding and efficiency/cost saving through individual and unit incentives.

New Research Initiatives

In order to make the most of precious resources, CESR looks to groups of professors and staff to band together in common research areas so that resources spent on basic development work can have the most benefit for all. Teaching, research, and external collaborative efforts will all benefit from this synergistic environment.

The TTU "Smart Grid Group" is one such group of researchers who have banded together to build a microgrid "test bed". Research in the areas of electric power, smart grid, power electronics, power disturbance mitigation, communications, control, computer programming, and security can all benefit from this common research facility. The inclusion of wind and solar power sources highlights the interest in "green energy" research.

Another focus area for the center's research effort is "Infrastructure Materials". Faculty members interested in materials and energy use are working on developing energy efficient use of materials for infrastructure in conjunction with the Tennessee Department of Transportation (TDOT) and the National Science Foundation (NSF).

Electric Power

The emphasis of CESR in the area of electric power is still of primary importance. The DOE sponsored initiative for studying disturbances in the electric grid through a distributed array of frequency disturbance recorders has spawned the development of a Laboratory sized power grid (Labgrid), which will be incorporated into the new Smart Grid Group microgrid test bed.

Electromagnetic Transients: Most power system outages are caused by lightning. Studies are being conducted to mitigate the effects of lightning by reducing ground resistance.

Power Transfer Capability Improvement: Studies are being conducted on transmission capacity evaluation of existing lines using commercially available software. Studies have been done to improve power transfer capability by optimizing conductor configuration.

Power Plant Performance Improvement: Work is ongoing in the area of real-time performance monitoring. Advanced control algorithms for improved control of power plant components are being studied.

Application of Neural Networks for understanding the effects of various parameters on plant performance is being implemented.

Robotics Application for Boiler Tube Inspection: Robots have been developed for inspecting boiler tubes using non-destructive evaluation (NDE) equipment. Special robots have been developed for inspecting storage tanks and penstocks in hydroelectric stations.

Power Systems Performance Improvement

Smart grid research and development (solar, wind and battery power and interconnection with existing grid, smart grid security, FNET application for power system performance predictions and improvement, Microgrid Technology)

Coal-fired power plant performance monitoring in real-time

Environmental Issues and Energy Conservation

High volume flyash utilization for highway and building construction

Traffic engineering

Improved thermal insulation technologies

Performance improvement of HVAC systems

Reuse of industrial solid waste material

Advanced Technologies

CFD and solid mechanics modeling application to industrial problems

Robotics application to power and other industries

Multi-phase open winding motors and permanent magnet machines actuated with dual multi-phase, multi-level converters

Modeling of electro-chemical systems

Combustion research

Nanotechnology application to material science

Research goals for 2011-2012 in the above-mentioned areas follow.

Smart grid research and development (solar, wind and battery power and interconnection with existing grid, smart grid security, FNET application for power system performance predictions and improvement, Microgrid Technology)

Coal-fired power plant performance monitoring in real-time

Utilize the full potential of the state-of-the-art Real-Time Digital Simulator (RTDS) and incorporate it into various research activities in the area of power systems performance improvement. Utilize the recently acquired current transformer laboratory facilities to study other types of transformers. Develop an intelligent load shedding scheme to improve power system stability by using FNET data. Extend research activities into the area of renewable energy. Continue working on modeling of batteries and extend the techniques to model fuel cells. Increase external funding above the two million dollar mark.

Investment in the Future

Develop a laboratory to study the effects on frequency in power systems

Develop fluid mechanics laboratory to include advanced flow measuring systems

Increase computational power by acquiring high-end work stations

SUPPORTING MATERIALS



Dr. Benjamin Mohr, Civil and Environmental Engineer, in his research laboratory with samples of corrugated concrete for research for his NSF Ettringite project.

Concrete samples can be stored in different environments and tested periodically for efforts of aging.

(Photo courtesy of CESR)

CESR FACULTY AND STAFF 2010-2011

Center Director:	Dr. Subramaniam Deivanayagam	Interim Director CESR
CESR Staff:	Robert Craven	R&D Engineer
	Anthony Greenway	Network Manager
	Linda Lee	Secretary III
	Etter Staggs	Financial Analyst
	Meharegzi Tewolde Abreham	Research Assistant I
	Will Mefford	Research Technician II / Laboratory Technician
	Dr. Charles Odeh	Research Assistant I
	Dr. Shaobu Wang	Post Doctoral Research Associate
	Dr. Mengesha Mamo Wogari	Research Assistant I

In addition to center faculty, the following faculty members participated in center activities during 2010-2011. Faculty involvement included conducting externally or internally funded research, preparing and presenting high quality research papers, preparing and marketing proposals, directing graduate students, and improving instructional courses and laboratories.

BASIC ENGINEERING

Ken Hunter

CHEMICAL ENGINEERING

Pedro Arce, Chairperson
Joseph Biernacki
Holly Stretz

ELECTRICAL & COMPUTER ENGINEERING

P.K. Rajan, Interim Chairperson
Ali Alouani
Omar Elkeelany
Satish Mahajan
Joseph Ojo
Ghadir Radman

CIVIL & ENVIRONMENTAL ENGINEERING

Xiaoming (Sharon) Huo, Interim Chairperson
Daniel A. Badoe
Steven Click
Lewis K. Crouch
Y. Jane Liu
Benjamin Mohr

MECHANICAL ENGINEERING

Darrell E. P. Hoy, Chairperson
Stephen Canfield
Jie Cui
Glenn Cunningham
Corinne M. Darvennes
Stephen A. Idem
John Peddieson
Hwan-Sik Yoon

ENGINEERING ADMINISTRATION

David Huddleston, Interim Dean
Subramaniam Deivanayagam,
Associate Dean for Graduate
Studies and Research

MANUFACTURING & INDUSTRIAL TECHNOLOGY

Ahmed H. ElSawy, Chairperson
Ismail Fidan
Ahmed Kamal

COMPUTER SCIENCE

Ambareen Siraj
Sheikh Ghafoor

CURRICULUM AND INSTRUCTION

Holly Anthony

MATHEMATICS

Sabine Le Borne
David Smith

FACULTY EXPERTISE

CHEMICAL ENGINEERING

Pedro Arce: Electrokinetics-Soil Clean up – High Oxidation Cold Plasma Methods-Water Pollution Control – Gel Electrophoresis – Drug Delivery Materials – Modeling of Transport Process in Porous Media with Reactions

Joe Biernacki: Cement-based Materials – Micro-fluidics – Ceramic Materials – Electron Ceramics - Microelectromechanical Systems

Holly Stretz: Polymer processing – Surfactants – Composite Modeling – Nanoparticle Deposition – High temperature Composite Stability – Biodiesel Reaction Kinetics – Nanocomposites - Ablation

CIVIL AND ENVIRONMENTAL ENGINEERING

Daniel Badoe: Transportation Demand Analysis – Transferability of Demand Models – Transport Systems Analysis – Discrete Choice Models Applied to Travel Demand – Travel Surveys

Steven Click: Traffic signal operations – Traffic signal system operations – Urban arterial operations – Traffic signal controller functions – Traffic signal master controller functions – Non-traditional intersection and arterial designs

L.K. Crouch: Aggregates – Portland Cement Concrete – Controlled Low-strength Materials – Hot-mix Asphalt – Construction Materials Testing

R. Craig Henderson: Masonry Design – Seismic Design – Earthquake Engineering – Structural Codes – Infilled Frames

X. Sharon Huo: Structural Analysis – Prestressed Concrete Analysis and Design – Bridge Analysis and Design – Reinforced Concrete Analysis and Design – Structural Steel Analysis and Design

Y. Jane Liu: Applied Mechanics – Finite Element Analysis – Advanced Computational Mechanics – Composite Materials – Plates and Shells Analysis

Benjamin Mohr: Durability, with an emphasis on nano/microstructure; microstructure, and chemistry of cement-based materials – Early-age behavior of cement and concrete – Fiber-reinforced concrete – Supplementary cementitious materials

Guillermo Ramirez: Computational and Theoretical Mechanics – Laminated Plates and Shells – Piezo and Magneto Elastic Solids – Smart Structures

ELECTRICAL AND COMPUTER ENGINEERING

Ali Alouani: Signal Processing and Control – Fuzzy Logic – Power Systems – Complex Systems – Sensor Data Fusion

Satish Mahajan: Lasers – LEDs – Solar Cells – Optical Fibers – High Power Switchgear

Joseph Ojo: Electric Machine Analysis and Design – Adjustable-Speed Motor Drives – Power Electronic Converters – Control Theory Applied to Power Electronics and Power Systems – Power Systems Economics and Deregulation Issues

Ghadir Radman: Modeling / Simulation of Power Systems – Dynamics / Transient Stability in Power Systems – Flexible AC Power Transmission (FACTS) – Power Flow / Optimal Power Flow – Reactive Power Compensation and Voltage Stability

P.K. Rajan: Circuits and Signals – Digital Signal Processing – Independent Component Analysis – Digital Image Processing, Pattern Recognition

Arun Sekar: Power Systems – Electrical Machines – Power Electronics

FACULTY EXPERTISE (CONTINUED)

MECHANICAL ENGINEERING

Steve Canfield: Robotics – Dynamic Modeling – Compliant Mechanisms – Smart Actuators – Mechatronics

Jie Cui: Computational Fluid Dynamics – Turbulence Modeling – Large Eddy Simulation – Numerical Heat Transfer – Thermal Fluids

Glenn Cunningham: Remaining Life Analysis – Fatigue, Creep and Fracture Analysis – Thermal Sciences – Energy Conservation and Management – Heating, Ventilation, and Air Conditioning (HVAC)

Corrine Darvennes: Acoustics – Noise Control – Ultrasonics – Nondestructive Evaluation

Stephen Idem: Scale Model Testing – Fluid Flow Measurement – Thermal Modeling – Fluid Mechanics– Heat Transfer

John Peddieson: Multiphase Flow – Friction Stir Welding – Tether Dynamics – Fluid Mechanics – Solid Mechanics

MANUFACTURING AND INDUSTRIAL TECHNOLOGY

Ahmed EISawy: Development of Manufacturing Processes – Welding Engineering and Metallurgy – Recycling and Reuse of Industrial Solid Waste Materials – Web-based Distance Learning – Computer Applications in Technology

Ismail Fidan: Manufacturing Processes – Electronics Manufacturing – Knowledge-based Systems – Web-based Distance Learning – Rapid Prototyping

Ahmed Kamal: Embedded Control System – Sensor and Biosensor – Digital Signal Processing – Biomedical System – System Identification

MATHEMATICS

Sabine Le Borne: Computational Fluid Dynamics – Multi-Grid Methods – Hierarchical Matrices

Activated Between July 1, 2010 and June 30, 2011

POWER SYSTEMS PERFORMANCE IMPROVEMENT

Contract Number	Title	Source	Project Dates	Total Amount	Estimated Expendit.
532344	Performance Optimization and Extended Speed Control of Multi-Phase Winding Induction (Year 3 of 3)	Office of Naval Research	7/1/2010-9/30/2011	76,322	265,912
531652	CAREER: Wind Power - Multi-Level Control, Intelligent Grid Integration and Real Time Digital Simulation (Year 2 of 5)	National Science Foundation	9/1/2010-8/31/2011	80,000	6,760
SUB - TOTAL				156,322	
POWER SYSTEMS PERFORMANCE IMPROVEMENT					272,672

CONTRACT AND GRANT AWARDS

SM-3

Activated Between July 1, 2010 and June 30, 2011

ENVIRONMENTAL ISSUES AND ENERGY CONSERVATION

Contract Number	Title	Source	Project Dates	Total Amount	Estimated Expendit.
539322	Development of Tennessee Travel Demand Model Users' Group (Year 1 of 3)	University of Tennessee-Knoxville (Funded by the Tennessee Department of Transportation)	6/1/2010-5/31/2011	9,000	8,416
539322	Development of Tennessee Travel Demand Model Users' Group (Year 2 of 3)	University of Tennessee-Knoxville (Funded by the Tennessee Department of Transportation)	6/1/2011-5/31/2012	9,250	0
SUB - TOTAL ENVIRONMENTAL ISSUES AND ENERGY CONSERVATION				18,250	8,416

Activated Between July 1, 2010 and June 30, 2011

ADVANCED TECHNOLOGIES

Contract Number	Title	Source	Project Dates	Total Amount	Estimated Expendit.
539234	Advanced Systems Development of the MRWS: a Remote Climbing Robot for Automating Welding Processes in the Ship Building Industry	National Shipbuilding Research Program (Subcontract through Advanced Technology Institute)	6/28/2010-1/31/2012	24,011	13,195
539275	Simplified Live Load Distribution Factor Equations for Tennessee Highway Bridge Design - Federal (Year 2 or 2)	Tennessee Department of Transportation	9/15/2010-9/14/2011	26,000	26,796
539276	Simplified Live Load Distribution Factor Equations for Tennessee Highway Bridge Design - State (Year 2 or 2)	Tennessee Department of Transportation	9/15/2010-9/14/2011	6,500	5,975
539274	Optimum Air Content Range (Plastic and Hardened) for TDOT Class D Portland Cement Concrete (PCC) - Federal (Year 2 of 3)	Tennessee Department of Transportation	9/15/2010-9/14/2011	40,000	46,868
539277	Optimum Air Content Range (Plastic and Hardened) for TDOT Class D Portland Cement Concrete (PCC) - State (Year 2 of 3)	Tennessee Department of Transportation	9/15/2010-9/14/2011	10,000	14,038

Activated Between July 1, 2010 and June 30, 2011

ADVANCED TECHNOLOGIES (continued)

Contract Number	Title	Source	Project Dates	Total Amount	Estimated Expendit.
531216	Nanoscale Characterization of Expansion Due to Delayed Ettringite Formation	National Science Foundation (CMMI)	9/1/2010-8/31/2011	75,716	49,474
531651	Algebraic Hierarchical Matrix Preconditioners for Two- and Three-Dimensional Saddle Point Problems (Year 2 of 3)	National Science Foundation (CCLI)	7/1/2010-6/30/2011	50,945	32,428
539510	Enabling Children with Disabilities and Their Families in Tennessee through Technology EIME Project (Preschool)	State Department of Education -- Division of Special Education	7/1/2010-6/30/2011	28,000	30,300
539511	Enabling Children with Disabilities and Their Families in Tennessee through Technology EIME Project (School Age)	State Department of Education -- Division of Special Education	7/1/2010-6/30/2011	7,000	7,752
536229	Evaluation of Low-Cost Digital Image Correlation for Strength Tests	United Launch Alliance	10/16/2010-11/30/2010	20,100	28,100
533216	Field Evaluation of Traffic Signal Based Interchange Treatments -- State (Year 2 of 3)	Tennessee Department of Transportation	1/1/2011-12/31/2011	13,400	4,994

CONTRACT AND GRANT AWARDS

SM-3

Activated Between July 1, 2010 and June 30, 2011

ADVANCED TECHNOLOGIES (continued)

Contract Number	Title	Source	Project Dates	Total Amount	Estimated Expendit.
539278	Field Evaluation of Traffic Signal Based Interchange Treatments -- Federal (Year 2 of 3)	Tennessee Department of Transportation	1/1/2011-12/31/2011	53,600	32,984
539279	Higher Volume Fly Ash PCC for Sustainability and Performance - Federal (Year 1 of 2)	Tennessee Department of Transportation	7/15/2010-7/14/2011	52,000	38,829
539280	Higher Volume Fly Ash PCC for Sustainability and Performance - State (Year 1 of 2)	Tennessee Department of Transportation	7/15/2010-7/14/2011	13,000	8,670
531258	Enhancing the Programming Experience for Engineering Students through Hands-On Integrated Computer Experiences: Phase II	National Science Foundation	9/15/2010-9/14/2011	233,713	49,391
535219	Using Solar Power for Chevy Volts Commuters: Feasibility Study	Merritt Island Holdings, LLC	12/18/2010-6/15/2011	16,302	16,302
536230	Large Strain Behavior of Rohacell	United Launch Alliance	4/27/2011-11/30/2011	20,000	0
SUB - TOTAL ADVANCED TECHNOLOGIES				690,287	406,096

**CONTRACT AND GRANT AWARDS
Activated Between July 1, 2010 and June 30, 2011**

POWER-TEST-SERVICE ACCOUNT

Contract Number	Title	Source	Project Dates	Total Amount	Estimated Expendit.
538597	Power-Test-Service Account (Funds Carried Over from 2009-2010)				14,888
	Cylinder Testing	ECE Services	3/21/10-6/25/10	100	100
	Cylinder Testing	ECE Services	3/21/10-6/25/10	765	765
	ACI-522R-10 Pervious Concrete	Tennessee Concrete Association	9/1/10-9/21/10	41	41
	Cylinder Testing	Cleary	9/21/10-10/21/10	100	100
	Cylinder Testing	ECE Services	9/21/10-2/14/11	1,715	1,715
	Cylinder Testing	ECE Services	6/21/10-10/19/10	1,165	1,165
	Engineering Services -- Assistance with preparation and review of RPF for the City of Charlotte Signal System	Mekuria Engineering	3/1/10-10/29/10	2,560	0
	Laboratory Testing of Fabric Air Dispersion System Friction Loss	DuctSox	11/1/10-1/31/11	3,500	3,426
	Cylinder Testing	ECE Services	12/18/10-4/18/11	1,320	1,320
SUB - TOTAL				11,266	23,520
POWER-TEST-SERVICE ACCOUNT					

**CONTRACT AND GRANT AWARDS
Activated Between July 1, 2010 and June 30, 2011**

MISCELLANEOUS

Contract Number	Title	Source	Project Dates	Total Amount	Estimated Expendit.
229342	TTU Research		7/1/2010-6/30/2011	13,410	12,916
229638	IC Faculty Energy Systems Gao (\$4,970 was carried over from 2009-2010)		7/1/2010-6/30/2011	0	4,970
229660	IC Faculty Energy Systems Munukutla (\$2,640 was carried over from 2009-2010)		7/1/2010-6/30/2011	7,020 0	3,388 2,640
SUB - TOTAL MISCELLANEOUS				20,430	23,914
TOTAL CONTRACTS AND GRANTS: 2010 - 2011				896,555	734,618

**STATUS OF PROPOSALS
Submitted Between July 1, 2010 and June 30, 2011**

	TITLE	INVESTIGATORS	SOURCE	AMOUNT	STATUS
1.	CAREER: Nanoparticle Barrier Layers: Strengthening the Network	Dr. Holly A. Stretz	National Science Foundation	409,470	Unfunded
2.	Development of Tennessee Travel Demand Model Users' Group	Dr. Daniel A. Badoe	University of Tennessee--Knoxville (Funded by the Tennessee Department of Transportation)	27,750	Funded
3.	Fault-Tolerant Water Current Turbine Power Generation for the Grid	Dr. Joseph Ojo	National Science Foundation	330,454	Unfunded
4.	Evaluation of Low-Cost Digital Image Correlation for Strength Tests	Dr. Jane Liu, Dr. John Peddieson	United Launch Alliance	20,100	Funded
5.	Enabling Children with Disabilities and Their Families in Tennessee through Technology EIME Project	Dr. Stephen L. Canfield, Dr. Hwan-Sik Yoon	State Department of Education -- Division of Special Education	35,000	Funded
6.	Using Solar Power for Chevy Volts Commuters: Feasibility Study	Dr. Ali Alouani	Merritt Island Holdings, LLC	16,302	Funded
SUBTOTAL, PROPOSALS FOR 2010-2011				839,076	

**STATUS OF PROPOSALS
Submitted Between July 1, 2010 and June 30, 2011**

	TITLE	INVESTIGATORS	SOURCE	AMOUNT	STATUS
7.	MRI: Acquisition of Research and Education Equipment for Smart Grid	Dr. Robert Qiu, Dr. Ghadir Radman, Dr. Ali Alouani, Dr. Omar Elkeelany, Dr. Ambareen Siraj	National Science Foundation	242,880	Pending
8.	Design of a Slug Drop and Conveyor System	Dr. Ali Alouani	ABC Group Fuel Systems, Inc.	67,416	Pending
9.	CAREER: Wind Power - Multilevel Control, Intelligent Grid Integration and Real Time Digital Simulation (Supplement)	Dr. Jie Cui	National Science Foundation	99,404	Pending
10.	Large Strain Behavior of Rohacell	Dr. Jane Liu, Dr. John Peddieson	United Launch Alliance	20,000	Funded
11.	Laboratory Testing of Flat Oval Transitions to Determine Loss Coefficients	Dr. Stephen Idem	ASHRAE, Inc.	79,996	Pending
12.	Laboratory Testing of Flexible Duct Note: Submitted at \$36,000 Revised to \$18,000	Dr. Stephen Idem	Thermafex, Inc.	36,000	Funded at \$18,000
SUBTOTAL, PROPOSALS FOR 2010-2011				545,696	

Submitted Between July 1, 2010 and June 30, 2011

	TITLE	INVESTIGATORS	SOURCE	AMOUNT	STATUS
13.	Development of a TDOT Class D-LP (Lower Permeability) Concrete Mixture	Dr. L. K. Crouch, Dr. Benjamin Mohr	Tennessee Department of Transportation	125,000	To be Funded during 2011-2012
14.	Developing a TDOT Class S-LH (Lower Heat) PCC Mixture Specification	Dr. L. K. Crouch	Tennessee Department of Transportation	200,000	Pending
15.	Developing Rating Aids for the Evaluation of Existing Concrete Box Culverts in Tennessee	Dr. Xiaoming Sharon Huo	Tennessee Department of Transportation	118,000	To be Funded during 2011-2012
16.	Innovation in Integrating Theory and Practice in Teaching the Industrial Electronics Course	Dr. Ahmed Kamal	National Science Foundation	178,718	Pending
SUBTOTAL, PROPOSALS FOR 2010-2011				621,718	
TOTAL, PROPOSALS FOR 2010-2011				2,006,490	

STATUS OF PENDING PROPOSALS

SM-5

STATUS OF PROPOSALS -- PENDING AND UNFUNDED Submitted Between July 1, 2009 and June 30, 2010

	TITLE	INVESTIGATORS	SOURCE	AMOUNT	STATUS
1.	Supplement to Transport Kinetics of Internal Curing Water in High Performance Concretes	Dr. Benjamin Mohr	National Science Foundation	9,765	Unfunded
2.	CAREER: Nanoscale Characterization of Expansion Due to Delayed Ettringite Formation	Dr. Benjamin Mohr	National Science Foundation	400,002	Unfunded
3.	CAREER: Dynamical Interaction of Sessile Drops with Multiscale Surface Heterogeneities	Dr. Mahesh Panchagnula	National Science Foundation	468,256	Unfunded
4.	CAREER: Nanoparticle Barrier Layers: Strengthening the Network	Dr. Holly Stretz	National Science Foundation	439,104	Unfunded
5.	CAREER: Wind Power - Multi-Level Control, Intelligent Grid Integration and Real Time Digital Simulation	Dr. Wenzhong Gao	National Science Foundation	400,000	Funded in 2009-2010
6.	National Wind Energy Consortium	Dr. Wenzhong Gao, Dr. Sastry Munukutla, Dr. Ghadir Radman, Dr. Jie Cui	U. S. Department of Energy (ARRA)	12,000,000	Unfunded
SUBTOTAL, PROPOSALS FOR 2009-2010				13,717,127	

**STATUS OF PROPOSALS -- PENDING AND UNFUNDED
Submitted Between July 1, 2009 and June 30, 2010**

	TITLE	INVESTIGATORS	SOURCE	AMOUNT	STATUS
7.	MRI-R2: Acquisition of Nanoindenter for Characterization of Advanced High Performance Materials	Dr. Benjamin Mohr, Dr. L. K. Crouch	National Science Foundation	534,136	Unfunded
8.	Preliminary Investigation of Beneficial Uses of Kingston Ash Material	Dr. L. K. Crouch, Dr. Lenly Weathers, Dr. Daniel Badoe	Tennessee Department of Transportation	105,000	Funded in 2009-2010
9.	Risk Assessment and Optimization of Power Grid Operation with Variable Renewable Generation	Dr. Wenzhong Gao	U. S. Department of Energy	1,164,380	Unfunded
10.	Field Evaluation of Traffic Signal Based Interchange Treatments	Dr. Steven Click	Tennessee Department of Transportation	200,000	Funded in 2009-2010
11.	Simplified Live Load Distribution Factor Equations for Tennessee Highway Bridge Design	Dr. Xiaoming Sharon Huo	Tennessee Department of Transportation	65,000	Funded in 2009-2010
12.	GOALI: A Unified Multiphase Transport Model of Spray Atomization, Evaporation and Combustion	Dr. Mahesh Panchagnula, Dr. Jie Cui, Dr. John Peddieson	National Science Foundation	299,967	Unfunded
SUBTOTAL, PROPOSALS FOR 2009-2010				2,368,483	

STATUS OF PENDING PROPOSALS

SM-5

STATUS OF PROPOSALS -- PENDING AND UNFUNDED Submitted Between July 1, 2009 and June 30, 2010

	TITLE	INVESTIGATORS	SOURCE	AMOUNT	STATUS
13.	GOALI: Development and Application of a General Elastic Stability Theory Accounting for Initial Imperfections	Dr. Jane Liu, Dr. John Peddieson	National Science Foundation	299,967	Unfunded
14.	Water Current Turbine Power Generation for the Grid	Dr. Joseph Ojo	National Science Foundation	326,333	Unfunded
15.	Optimum Air Content Range (Plastic and Hardened) for TDOT Class D PCC	Dr. L. K. Crouch, Dr. Benjamin Mohr, Dr. Daniel Badoe, Dr. Jane Liu	Tennessee Department of Transportation	130,000	Funded in 2009-2010
16.	Enhancing the Programming Experience for Engineering Students through Hands-On Integrated Computer Experiences: Phase II Proposal	Dr. Stephen Canfield, Dr. Mohamed Abdelrahman, Dr. Sheikh Ghafoor, Dr. Holly Anthony, Dr. David Smith	National Science Foundation	600,000	Funded in 2010-2011
17.	Collaborative Education Research: Transforming iTECH to ECE Through Agent-Based Network System for STEM Learning Environment	Dr. Ismail Fidan, Dr. Holly Anthony	National Science Foundation	400,000	Unfunded
SUBTOTAL, PROPOSALS FOR 2009-2010				1,756,300	

**STATUS OF PROPOSALS -- PENDING AND UNFUNDED
Submitted Between July 1, 2009 and June 30, 2010**

	TITLE	INVESTIGATORS	SOURCE	AMOUNT	STATUS
18.	REU Site: Design and Development of Medical Diagnosis Support Systems	Dr. Ahmed Kamal, Dr. Ali T. Alouani, Dr. Omar Elkeelany	National Science Foundation	329,829	Unfunded
19.	Enabling Families, Infants, and Toddlers Through Technology: Merging Early Intervention and Mechanical Engineering (EIME)	Dr. Stephen Canfield, Mr. Ken Hunter	Tennessee State Department of Education -- Division of Special Education	35,000	Funded in 2009-2010
20.	High Performance Computing Based Numerical Modeling of Friction Stir Welding	Dr. Jie Cui	Oak Ridge Associated Universities Partnerships Office	75,000	Unfunded
21.	Modeling of Moisture Diffusion in Composites	Dr. John Peddieson, Dr. Jane Liu	United Launch Alliance	8,000	Funded in 2009-2010
22.	Advanced Systems Development of the MRWS: a Remote Climbing Robot for Automating Welding Processes in the Ship Building Industry	Dr. Ahmed Elsayy	National Shipbuilding Research Program (NSRP) (A subcontract through Advanced Technologies Institute)	24,011	Funded in 2010-2011
23.	High Volume Fly Ash PCC for Sustainability and Performance	Dr. L. K. Crouch, Dr. Ben Mohr, Dr. Daniel Badoe	Tennessee Department of Transportation	130,000	Funded in 2010-2011
SUBTOTAL, PROPOSALS FOR 2009-2010				601,840	

STATUS OF PENDING PROPOSALS

SM-5

STATUS OF PROPOSALS -- PENDING AND UNFUNDED Submitted Between July 1, 2009 and June 30, 2010

	TITLE	INVESTIGATORS	SOURCE	AMOUNT	STATUS
24.	Validation of a Low-Order Acoustic Model of Boilers and its Application for Diagnosing Combustion Driven Oscillations	Dr. John Peddieson, Dr. Stephen Idem	ASHRAE, Inc.	119,743	Unfunded
25.	Innovation in Teaching Industrial Electronics Course	Dr. Ahmed Kamal	National Science Foundation	189,180	Unfunded
26.	Decentralized Intelligent Architecture for Distribution-Grid Health Management	Dr. Ali Alouani, Dr. Satish Mahajan, Dr. Ghadir Radman, Dr. Omar Elkeelany, Dr. Ambareen Siraj	U. S. Department of Energy	1,137,076	Unfunded
27.	Development of a Wire Core Transformer	Dr. Satish Mahajan	Buswell Energy, LLC	74,999	Funded in 2009-2010
28.	Smart Grid Research	Dr. Sastry Munukutla, Dr. Wenzhong Gao, Dr. Joseph Ojo, Dr. Ghadir Radman, Dr. Omar Elkeelany, Dr. John Peddieson, Dr. Jie Cui, Dr. Ambareen Siraj, Mr. Robert Craven	Oak Ridge National Laboratory (Department of Energy)	415,000	Funded in 2009-2010
29.	Nanoscale Characterization of Expansion Due to Delayed Ettringite Formation	Dr. Benjamin Mohr	National Science Foundation	340,472	Funded at \$299,943 in 2010-2011
SUBTOTAL, PROPOSALS FOR 2009-2010				2,276,470	
TOTAL, PROPOSALS FOR 2009-2010				20,720,220	

ALOUANI, ALI

A.T. Alouani, O. Elkeelany, and M. Abdallah, "Stand-alone portable digital body sound data acquisition device", *International Journal of Embedded Systems*, vol.4, no. 3/4, 2010

BADOE, DANIEL

Badoe, D.A. and Mwakalonge, J. (2011), Estimating Household Trip-rates for Cross-Classification Cells with No Data: Alternative Methods and their Performance in Prediction of Travel, *in press ASCE Journal of Urban Planning and Development*

Mwakalonge, J. and Badoe, D.A. (2011) Trip Generation Modeling Using Data Collected in Single and Repeated Cross-Sectional Surveys. Proceedings of the 90th Annual Transportation Research Board Conference, Washington D.C., 2011

BIERNACKI, JOSEPH

J. J. Biernacki, E. Thurber, R. Pavlovski, D. P. Visco, M. Oyanader and H. Stretz, *Research Experience for Teachers in Manufacturing for Competitiveness in the United States-RetainUS*, AIChE Annual Meeting, November 2010.

J. D. Murillo, T. Hughes, P. Ambuken, J. J. Biernacki, and C. P. Bagley, *Comparative Pyrolysis Kinetics for One Legume and Two Grass Hays*, AIChE Annual Meeting, November 2010.

N. K. R. Tadisina, D. P. Visco, Jr., J. J. Biernacki, H. Kayello, N. Shlonimskaya, *Prediction of Surface Tension for Dilute Binary Aqueous Systems Using a Molecular Thermodynamic-Based Model*, AIChE Annual Meeting, November 2010.

J. J. Biernacki, T. Xie, *A Mass Continuity-Based Continuum Mechanical Single Particle Model for Alite/C₃S Hydration*, American Ceramics Society, Cements Division Annual Meeting, July 2010.

BUCHANAN, GEORGE

Jane Liu, George Buchanan "Application of Groebner Bases in Methodology to Nonlinear Analysis of an Underwater Cable,"(full paper accepted) Proc. 30th International Conference on Ocean, Offshore and Arctic Engineering on CD, Rotterdam, The Netherlands, June 19-24, 2011.

CANFIELD, STEPHEN

Canfield, S. L., Peddieson, J, and G. Garbe, 2010 "Similarity Rules for Scaling Solar Sail Systems," *Journal of Spacecraft and Rockets*, Vol. 48, No. 1, pp. 218.

Canfield, S. L., and A. O'Toole, "Introducing Autonomous Manufacturing Devices into the Shipbuilding Industry," submitted to *International Journal of Agile Manufacturing*, January, 2010.

Canfield, S. L, Shibakov, A., and J. Richardson, "Design Space Analysis of Distributed Compliance in Segmented Beam Templates of Compliant Mechanisms," submitted to the *ASME Journal of Mechanical Design*, 2010.

O'Toole, A and S. L. Canfield, "Developing a Kinematic Estimation Model for a Climbing Mobile Robotic Welding System," *Proc. of the 2010 ASME International Design Engineering Technical Conferences*, Montreal Quebec, Canada, Aug. 15-18, 2010, DETC2010-28878.

Canfield, S. L, and L. Smith, "Providing Real-World Mechanism Design Experience through the Early Intervention and Mechanical Engineering (EIME) Project," *Proc. of the 2010 ASME International Design Engineering Technical Conferences*, Montreal Quebec, Canada, Aug. 15-18, 2010, DETC2010-29019.

CLICK, STEVEN

"Evaluation of Traditional and Non-Traditional Interchange Treatments to Preserve the Service Life of Narrow Over- and Underpass Roadways" *Transportation Research Record: Journal of the Transportation Research Board*. Volume 2171, 2010.

CROUCH, L.K.

Crouch, L. K., and Medley, Martin, 2010 "The Road to Shambala," *Tennessee Concrete Magazine*, Vol. 24, No. 2, pp. 8-9.

Crouch, L. K., 2010 "Help for Pervious PCC Producers, Part 1: Supplementary Cementing Material Substitution Rates –It's Good to be Green," *Tennessee Concrete Magazine*, Vol. 24, No. 2, pp. 10-15.

CUI, JIE

Devendra, Idem, Cui, "Laboratory Testing of Converging Flow Flat Oval Fittings to Determine Loss Coefficients (RP-1488)," *International Journal of Heating Ventilating Air Conditioning and Refrigerating Research*, accepted for publication, 2011.

Cui, J., Nadkarni, M., Mahajan, S. and Robilino, D. M., "Numerical Analysis of Transient Temperature Distribution in a Current Transformer," *ASME Journal of Thermal Science and Engineering Applications*, Vol. 2, Issue 3, DOI: 10.1115/1.4003068, 2010.

Roberts, R. and Cui, J., "Selection of the Simulation Domain and Turbulence Models for Flow around an Airfoil," *Engineering Applications of Computational Fluid Mechanics*, Vol. 4, No. 3, pp. 441-449, 2010.

Escue, A., and Cui, J., "Comparison of Turbulence Models in Simulating Swirling Pipe Flows," *Applied Mathematical Modeling*, Vol. 34, pp. 2840-2849, DOI:10.1016/j.apm.2009.12.018, 2010.

Cui, J., Mahajan, S., Robalino, D., "Modeling of Temperature Distribution inside a Current Transformer," paper IMECE2010-37544, ASME International Mechanical Engineering Congress and Exposition, Vancouver, British Columbia, Canada, November 12-18, 2010.

Bangaru, S., Cui, J., "CFD Simulation of Flow in a Circular Pipe with Percina Rex Fish," paper IMECE2010-39973, ASME International Mechanical Engineering Congress and Exposition, Vancouver, British Columbia, Canada, November 12-18, 2010.

IDEM, STEPHEN

Gibbs, D.C. and Idem, S., 2011, "Measurements of Flat Oval Diverging Flow Fitting Loss Coefficients," *ASHRAE Transactions*, In Press.

Silaipillayarputhur, K. and Idem, S., 2011, "Spark Advance Effects in Spark Ignition Engines," Proceedings, Intellectbase International Consortium Academic Conference, Nashville, TN.

Silaipillayarputhur, K. and Idem, S., 2011, "Late Intake Valve Closing and Early Exhaust Valve Opening in a Four Stroke Spark Ignition Engine," Proceedings, Intellectbase International Consortium Academic Conference, Nashville, TN.

Gibbs, D.C. and Idem, S., 2010, "Flat Oval Duct Leakage Class Measurement," *ASHRAE Transactions*, Vol. 116, Part 2, pp. 387-393.

Gibbs, D.C. and Idem, S., 2010, "Measured and Predicted Pressure Loss in Corrugated Spiral Duct," *ASHRAE Transactions*, Vol. 116, Part 2, pp. 380-386.

Khaire, S. and Idem, S., 2010, "Influence of Test Section Entrance Conditions on Straight Flat Oval Duct Apparent Relative Roughness," *ASHRAE Transactions*, Vol. 116, Part 2, pp. 371-379.

LE BORNE, SABINE

S. Boerm, S. Le Borne. H-LU factorization in preconditioners for augmented Lagrangian and grad-div stabilized saddle point systems, to appear in *International Journal for Numerical Methods in Fluids* (2010).

LIU, JANE

Jane Liu, George Buchanan "Application of Groebner Bases in Methodology to Nonlinear Analysis of an Underwater Cable,"(full paper accepted) Proc. 30th International Conference on Ocean, Offshore and Arctic Engineering on CD, Rotterdam, The Netherlands, June 19-24, 2011.

MAHAJAN, SATISH

Satish M. Mahajan, Detection of Saturation, and Reconstruction of the Secondary Current of a CT" (with G.B. Kumbhar), International Journal of Emerging Electric power Systems (JEEPS), Vol. 11 (1), article 7, 2010.

S. Mahajan, "Quartz crystal tuning fork photoacoustic point sensing" (with Charles Van neste, L. Senesac, and T. Thundat), Sensors & Actuators: B. Chemical, Volume B150, Issue 1, September 2010, pp. 402-405.

S. Mahajan, "Capacitive Weighting technique for Estimating the 3D Turn-Level Capacitance in a Transformer Winding", (with A.J. Thomas), Accepted in July 2010 by the Electric Power Systems Research (Elsevier), Vol. 81 (2011), 117-122.

S. Mahajan, "Thermal Modeling of an Inverted type Oil-Immersed Current Transformer", (With V. Sivan, and D.M. Robalino), IEEE Transactions of Power Delivery, Vol.25 No. 4, October 2010, pp. 2511-2518.

S. Mahajan, "Reduction in Losses and Local Overheating of the Tank of a Current Transformer" (with G. Kumbhar, and W.L. Collett), IEEE Transactions on Power Delivery, Vol. 25. No. 4, October 2010, pp 2519-2525.

S. Mahajan, "Numerical Analysis of Transient Temperature Distribution Inside a Current Transformer", (with J. Cui, M. Nadkarni, and D.M. Robalino), Journal of Thermal Science and Engineering Applications, Vol 2 (3), September 2010/031005-1 doi:10.1115/1.4003068.

MOHR, BENJAMIN

Mohr, B.J., Hood, K.L. "Influence of Bleed Water Reabsorption on Cement Paste Autogenous Deformation." *Cement and Concrete Research*, 2010; 40(2):220-225.

MUNUKUTLA, SASTRY

"Simulation of Particle/Fluid Flows in Vertical Circular Pipes", (with R. You, J. Peddieson and J. Gadiyaram), International Journal of Non-Linear Mechanics, 45 (2010) pp. 490-506.

"Software for Inexpensive On-Line Monitoring of Efficiency and Greenhouse Gas Emissions in Coal-Fired Units", (with R. Craven), PowerGen-Asia Conference, November 2-4, 2010, Singapore.

"On-Line Monitoring of Efficiency and Greenhouse Gas Emissions in Coal-Fired Units", (with R. Craven), 2nd INEEE Conference, March 8-10, 2011, Venice, Italy.

PEDDIESON, JOHN

"Simulation of Beam Plastic Forming with Variable Bending Moments," with A. Natarajan, International Journal of Non-Linear Mechanics, 46, 2011, pp. 14-22.

"Simulation of Particle/Fluid Flows in Vertical Pipes," with R. You, J. Gadiyaram, and S. Munukutla, International Journal of Non-Linear Mechanics, 45, 2010, pp. 490-506.

"Analytical Solutions for Convective Fragmentation," with N. Rayapati, S. Bhamidipati, and M. Panchagnula, Mechanics Research Communications, 37, 2010, pp. 712-716.

"Analytical Solutions for Particulate Pipe Flows with Fragmentation, Evaporation, and Diffusion," with N. Rayapati, S. Bhamidipati, and M. Panchagnula, Mechanics Research Communications, 37, 2010, pp. 604-610.

"Nozzle 3 and DOE Study on Nozzle 4," with M. Panchagnula and J. Cui, final report submitted to Delevan, Inc. 2010.

"Derivation of Equations for Biaxial Stress Test," with J. Liu, final report submitted to United Launch Alliance, 2010.

"Evaluation of Low-Cost Digital Image Correlation for Strength Tests," with J. Liu, final report submitted to United Launch Alliance, 2010.

RADMAN, GHADIR

Ghadir Radman, Mehriar Aghazadeh Tabrizi, Rahul Kambhampaty, "Improvement of Micro Grid dynamics using Micro Grid Frequency Controller," submitted to 42th North American Power Symposium (NAPS 2011), USA.

Mehriar Aghazadeh Tabrizi, Ghadir Radman, Yunzhi Cheng, "Micro Grid voltage profile improvement using Micro Grid Voltage Controller," submitted to 42th North American Power Symposium (NAPS 2011), USA.

A. Tamersi, G. Radman, M. A. Tabrizi, "Enhancement of Micro Grid Dynamic Voltage Stability Using Micro Grid Voltage Stabilizer," in Proc. SOUTHEASTCON 2011, Nashville, TN., March, 2011

G. Radman, N. B. Hodges, and M. Aghazadeh Tabrizi, "Calculation of Dynamic Frequency Measured by PMUs/FDRs during Simulation Phase," submitted to IEEE Trans. On Power Syst. Sept. 2010.

M. Aghazadeh Tabrizi, G. Radman, "A PMU-Based Multi-Input SVC Supplementary Controller for Damping Inter-area Oscillation," in Proc. 42th North American Power Symposium (NAPS 2010), USA, Sept. 2010.

R. Hassan, M. Abdallah, G. Radman, F. Marco, S. Carroll, J. Wigington, J. Short, S. Hammer, J. Givens, D. Hislop, "Under-Frequency Load Shedding: Towards a Smarter Smart House with a Consumer Level Controller: Accepted in the IEEE SoutheastCon Conference.

RAMIREZ, GUILLERMO

Ramirez, F., P.R. Heyliger, G. Ramirez, J. Tamasco, "Monte Carlo Simulation of Low Density Fiber Composites," presented at the 9th World Congress on Computational Mechanics WCCM8/9th Asian-Pacific Congress on Computational Mechanics, Sidney, Australia, 2010.

Ramirez, F., J. Tamasco, P.R. Heyliger, G. Ramirez, "Simulacion Computacional de Compuestos Fibrosos de Baja Densidad," Published by the Universidad de Antioquia, Vol. 54, pp. 75-83, August 2010.

SIRAJ, AMBAREEN

Summer Olmstead and Ambareen Siraj. "Smart Grid Insecurity: A New Generation of Threats", Proceedings; *International Conference on Security and Management (SAM'11)*, Las Vegas, NV, July 18-21, 2011.

Ambareen Siraj. "Service Learning through Development of Computer Security Awareness and Training (CSAT) Seminar", *The 15h Colloquium for Information Systems Security Education (CISSE'11)*, Fairborn, OH, June 13-15, 2011.

Joseph McDaniel and Ambareen Siraj, "Potential Use of Chaffing and Winnowing for Secure Communication in a WAMS Environment", Proceedings: *IASTED International Conference on Wireless Communications*, Vancouver, Canada, June 1-3, 2011.

Marbin Pazos-Revilla and Ambareen Siraj, "An Experimental Model of a FPGA-Based Fuzzy Intrusion Detection System", Proceedings: *26th International Conference on Computers and Their Applications (CATA-2011)* New Orleans, LA, March 23- 25, 2011.

IDEM, STEPHEN

Kulkarni, D., Cui, J., and Idem, S., 2011, "Laboratory Testing of Converging Flow Flat Oval Tees and Laterals to Determine Loss Coefficients," *HVAC&R Research*, In Press.

Cantrell, C. and Idem, S. 2010, "On-Line Performance Model of the Convection Passes of a Pulverized Coal Boiler," *Heat Transfer Engineering*, Vol. 31, No. 14, pp. 1173-1183.

Cantrell, C. and Idem, S. 2010, "U-Tube Assembly Heat Exchanger Performance Analysis Using Cyclic Iteration," *Heat Transfer Engineering*, Vol. 31, No. 13, pp. 1042-1050.

LE BORNE, SABINE

Workshop on "Fast Solvers for Partial Differential Equations", Mathematisches Forschungsinstitut Oberwolfach, May 22-28, 2011.

Invited participant "Block Preconditioners for Saddle Point Problems." at a minisymposium at the SIAM Computational Science and Engineering Conference in Reno, NV, Feb 28-Mar 4, 2011.

Invited presentation "Numerical Simulation of Fluid Flow" at the TTU chapter of Sigma Xi luncheon seminar on February 24, 2011. The purpose is to "promote knowledge of ongoing campus research in the science and engineering areas".

Participant at the Workshop on "Numerical Solutions of Partial Differential Equations: Fast Solution Techniques", Institute for Mathematics and Its Applications (IMA) at the University of Minnesota, MN, Nov. 29 - Dec. 3, 2010. Poster Title: "H-LU factorization of Stabilized Saddle Point Problems".

OJO, JOSEPH O.

Sosthenes Karugaba, Amrit Gautam, Olorunfemi Ojo, "Full order Modeling and Simulation of nine-Phase Interior Permanent Magnet Machine", accepted for presentation at the 2011 IEEE Energy Conversion Congress and Exposition (ECCE2011) to be held in Phoenix, Arizona, USA in September 17-22, 2011.

Sosthenes Karugaba, Amrit Gautam, Olorunfemi Ojo, "Modeling of Nine Phase Interior Permanent Magnet Machine Including Harmonic Effects," accepted for presentation at the International Electric Machines and Drives Conference (IEMDC2011) to be held in Niagara Falls, May 15-18 2011.

Sosthenes Karugaba, Amrit Gautam, Olorunfemi Ojo, "Full Order Modeling and Simulation of a Nine-Phase Interior Permanent Magnet Machine," accepted for presentation at the 2011 IEEE Energy Conversion Congress and Exposition (ECCE2011) to be held in Phoenix, Arizona, USA in September 17-22, 2011.

Sosthenes Karugaba, Amrit Gautam and Olorunfemi Ojo, "Modeling of Nine Phase Interior Permanent Magnet Machine Including Harmonic Effects," accepted for presentation at the International Electric Machines and Drives Conference (IEMDC2011) to be held in Niagara Falls, 15 – 18 May 2011.

Sosthenes Karugaba and Olorunfemi Ojo, "Carrier Based PWM Scheme for a Three-level Diode-Clamped Five-Phase Voltage Source Inverter Ensuring Capacitor Voltage Balancing," in the Conference Record of the 26th Annual IEEE Applied Power Electronics Conference & Exposition (APEC2011), Fort Worth, Texas, March 6-10, 2011.

Sosthenes Karugaba, Olorunfemi Ojo, "A Method for Five-Phase Carrier Based PWM Modulation for Balanced and Unbalanced Reference Voltages," in the Conference Record of IEEE Energy Conversion Congress and Expo (ECCE2010), September 12-16, 2010, Atlanta, Georgia.

Adeola Balogun, Olorunfemi Ojo, Frank Okafor, Sosthenes Karugaba, "Determination of Steady State Control Laws of Doubly – Fed Induction Generator using Natural and Power Variables," in the Conference Record of IEEE Energy Conversion Congress and Expo (ECCE2010), Georgia, pp. 1368 – 1375, September 12-16, 2010, Atlanta.

Melaku Mihret, Meharegzi Abreham, Olorunfemi Ojo, Sosthenes Karugaba, "Modulation Schemes for Five-Phase to Three-Phase AC-AC Matrix Converters," in the Conference Record of IEEE Energy Conversion Congress and Expo (ECCE2010), September 12-16, 2010, Atlanta, Georgia.

Olorunfemi Ojo, Meharegzi Abreham, Sosthenes Karugaba, Olusola Komolafe, "Carrier-Based Modulation of Non-Square Multi-Phase AC-AC Matrix Converters," in the Conference Record of IEEE International Symposium on Industrial Electronics (ISIE2010), July 4-7, 2010, Bari, Italy.

BOOK / CHAPTER PUBLICATIONS

ELKEELANY, OMAR

Omar Elkeelany, Dipankar Dasgupta, "Computational Intelligence in Securing Cyber Physical Systems," Accepted book chapter proposal in an edited handbook on "Securing Cyber-Physical Infrastructures: Foundations and Challenges." In progress, 2010.

O. Elkeelany, G. Chaudhry, "Electronic Data Streaming: Management, Processing and Transmission: FPGA Based Video Streaming System for Bi-Network Multicasting Protocols," Accepted Chapter. Nova Publications, 2010.

M. Abdallah, O. Elkeelany, "Towards affordable home health care devices using reconfigurable system-on-chip technology," submitted Book Chapter in Biomedical Engineering, InTech Publisher, 2010.

PRESENTATIONS

BIERNACKI, JOSEPH

J. J. Biernacki, *The Origins and Evolution of Cement Hydration Models*, Ohio University, September 14, 2010.

J. J. Biernacki, *An Advanced Single Particle Model for Alite and C₃S Hydration*, University of Illinois at Urbana-Champaign, August 6, 2010.

IDEM, STEPHEN

Speaker in seminar: "Laboratory Testing of Saddle Tap Tees to Determine Loss Coefficients," SPIDA Meeting-AHR Expo, Las Vegas, NV, 2011.

Speaker in seminar: "Laboratory Testing of Increased Area (Pressed) Saddle Tap Tees to Determine Loss Coefficients," SPIDA Annual Meeting, Nashville, TN, 2010.

CUNNINGHAM, GLENN

"Energy Efficiency with Centrifugal Pumps," Taught workshop for North Carolina State University Energy Management Diploma Program, Roanoke, VA, November 2009.

LE BORNE, SABINE

Funded participant at the Workshop on "Fast Solvers for Partial Differential Equations", Mathematisches Forschungsinstitut Oberwolfach, May 22-28, 2011.

"Block Preconditioners for Saddle Point Problems." Invited participant at a mini-symposium at the SIAM Computational Science and Engineering Conference in Reno, NV, Feb 28-Mar 4, 2011.

"Numerical Simulation of Fluid Flow." Invited presentation at the TTU Chapter of Sigma Xi at their luncheon seminar on February 24, 2011. The purpose is to "promote knowledge of ongoing campus research in the science and engineering areas".

Funded participant at the Workshop on "Numerical Solutions of Partial Differential Equations: Fast Solution Techniques", Institute for Mathematics and Its Applications (IMA) at the University of Minnesota, MN, Nov. 29 - Dec. 3, 2010. Poster Title: "H-LU factorization of Stabilized Saddle Point Problems".

OJO, JOSEPH

Panelist, "Modeling and Steady-State Operation of a Rotary Power Flow Controller", 8th International Conference on Power Systems Operation and Planning, Abuja, Nigeria, January 14 – 25, 2010.

Alouani, Ali T.

Member:

IEEE Control Systems Society
Optical Engineering

Arce, Pedro

Member:

American Institute of Chemical Engineering (AIChE), Senior Member (since 2004)
CAST, Chemical Reaction Engineering Divisions.
American Chemical Society (ACS)
American Society of Engineering Education (ASEE)
Society of Industrial and Applied Mathematics (SIAM),
Sigma Xi

Badoe, Daniel A.

Member:

Assoc. Member, American Society of Civil Engineers
Member, Institution of Transportation Engineers
Member, Southeastern Division of the Institute of Transportation Engineers
Judge, American Council of Engineering Companies of Tennessee Engineering Excellence Awards
Editorial Board Member, ASCE Journal of Urban Planning and Development
Proposal Reviewer for National Science Foundation
Paper Reviewer for National Science Foundation, Graduate Research Fellowship Program, European Journal of Operations Research, Journal of the Korean Society of Civil Engineers, Journal of the Transportation Research Board, Growth and Change, Transportation Research Part B: Methodological, and Environment and Planning

Biernacki, Joseph

Member:

American Ceramic Society
American Institute of Chemical Engineers
American Concrete Institute
American Society for Engineering Education
Tennessee Academy of Sciences
Sigma Xi

Buchanan, George

Member:

American Ceramic Society Profiles in Excellence -

Canfield, Steve

Member:

American Society of Mechanical Engineering (ASME)
American Society of Engineering Education (ASEE)
Sigma Xi
Phi Kappa Phi

Honors/Awards

Leighton E. Sissom Innovation and Creativity Award, College of Engineering, TTU, 2010

Click, Steven

Member:

Transportation Research Board
Institute of Transportation Engineers
American Society for Engineering Education
Traffic Signal Systems Committee of the Transportation Research Board (2008-present)
Proctor, Fundamentals of Engineering Exam (2006-present)
Reviewer of Papers for the 85th Annual Meeting of the Transportation Research Board (2006-present)

Crouch, L.K.

Member:

American Concrete Institute International
American Society for Testing and Materials
Member, Committee D-04 on Road and Paving Materials
Member, Committee C-09 on Concrete and Aggregates

Cui, Jie

Member:

American Society of Mechanical Engineers (ASME)
American Society of Heating, Refrigeration, Airconditioning Engineers (ASHRAE)

Darvennes, Corinne

Member:

Acoustical Society of America (ASA)
American Society of Mechanical Engineers (ASME)

Elkeelany, Omar

Member:

American Society of Engineering Education (ASEE)
IEEE Consumer Electronics Society
International. Academy of Science & Technology (IAST)
International Society for Computers & their Applications (ISCA)

EISawy, Ahmed

Member:

Sigma Xi
Scientific Research Society, Full Member.
American Society for Manufacturing Engineer
American Welding Society
American Society of Engineering Education
American Association of Industrial Technology
ASEE new teach award committee, 2010
ASEE engineering ethics competition committee, 2010
Keynote speaker for the Embedded System Conference, India, 2010
Science Fair Judge, March 2011

Fidan, Ismail

Member:

National Coalition of Advanced Technology Centers (NCATC)
Tennessee Academy of Science (TAS)
Society of Manufacturing Engineers (SME)
Institute of Electrical and Electronics Engineers (IEEE)
American Society of Mechanical Engineers (ASME)
American Society for Engineering Education (ASEE)

Gao, (David) Wenzhong

Member:

Institute of Electrical & Electronics Engineers (IEEE)
Power Engineering Society (PES)
American Society for Engineering Education (ASEE)

Henderson, R. Craig

Member:

Chi Epsilon
ASCE/ACI/TMS Masonry Standards Joint Committee (MSJC)

Huo, Xiaoming (Sharon)

Member:

American Society of Civil Engineers (ASCE)
American Concrete Institute (ACI)
American Society for Engineering Education (ASEE)
Precast/Prestressed Concrete Institute (PCI)

Idem, Stephen A.

Member:

American Society of Engineering Education (ASEE)
American Society of Heating, Refrigerating and
Air-Conditioning Engineers (ASHRAE)

Kamal, Ahmed

Member:

American Medical Physics Society
American Biomedical Science Instrumentation
Institute of Electrical & Electronic Engineers (IEEE)
Institute of IEE, England

Le Borne, Sabine

Reviewer:

Scientific journals (Computing, SIAM J. Sci. Comp.
SIAM J. Mat. Anal.
Journal Math

Served on NSF Panels

Liu, Y. Jane

Member:

Associate Member, American Society of Civil Engineers (ASCE)
American Society of Mechanical Engineers (ASME)
United States Association for Computational Mechanics (USACM)

Mahajan, Satish

Member:

Institute of Electrical and Electronic Engineers
Lasers and Electro-Optics Society
Power Engineering Society
Electron Devices Society
Sigma Xi
Tau Beta Pi
Eta Kappa Nu

Committee:

Estimation of Loss of Life of a 69 kV Current Transformer" IEEE Transformers Committee, October 2010, Toronto, Canada.
Served as referee of the annual "First Lego League Tournament" held at TTU.
Arranged a very successful Workshop on "Smart Grid" at TTU given by two experts (Drs. Rizzo and Tricoli) during November 2010 that was attended by a diverse audience of more than 60 individuals on TTU campus

Mohr, Benjamin

Member:

American Concrete Institute (ACI)

International Union of Laboratories & Experts in Construction Materials, Systems & Structures (RILEM) American Ceramic Society, Cements Division (ACerS)

Chair-Elect, 2011-2012

Secretary, 2010-2011

American Society of Civil Engineers (ASCE)

American Society of Engineering Education (ASEE)

Munukutla, Sastry

Member:

Associate Fellow, American Institute of Aeronautics and Astronautics (AIAA)

Fellow, American Society of Mechanical Engineers (ASME)

Ojo, Joseph O.

Senior Member:

Institute of Electrical and Electronics Engineers (IEEE)

Fellow, Institute of Electrical Engineers (IEE), (UK)

Member:

IEEE Static Power Conversion Committee

IEEE Industrial Drive Committee

IEEE Electric Machine Committee

Peddieson, John

Member:

Sigma Xi

Phi Kappa Phi

Society of Engineering Science

American Academy of Mechanics

American Filtration and Separation Society

Radman, Ghadir

Member:

Institute of Electrical and Electronics Engineers (IEEE) Power Engineering Society (PES)

Rajan, P.K.

Member:

Institute of Electrical and Electronics Engineers (IEEE)

IEEE Acoustics, Speech, and Signal Processing Society

IEEE Circuits and Systems Society

IEEE Education Society

American Society for Engineering Education (ASEE)

Tennessee Academy of Science

Sigma Xi

The Society for Scientific Research

Ramirez, Guillermo

Member:

Sigma Xi

Scientific Research Society

Sekar, Arun

Member:

Institute of Electrical and Electronics Engineers

Power Engineering Society

Siraj, Ambareen

Committees:

IT Curriculum Committee, Department of Computer Science, TTU.

Information Assurance and Security Programs Committee, Department of Computer Science, TTU.

Software Engineering Committee, Department of Computer Science, TTU.

Mary Patterson Committee, Department of Computer Science, TTU.

CESR Search Committee, 2011-2012.

ECE Search Committee, 2011-2012.

ECE Search Committee, 2010-2011.

International Affairs Committee, 2010-2011.

ABET Review Committee, Department of Computer Science, TTU, 2010.

Services:

Program Committee for the 26th International Conference on Computers and Their Applications (CATA-2011)

Reviewer for the 26th International Conference on Computers and Their Applications (CATA-2011)

Stretz, Holly

Member:

American Chemical Society

American Institute of Chemical Engineers

Sigma Xi

Society of Plastics Engineers

Society of Women Engineers

American Society of Engineering Educators (ASEE)

**Diana Tudor
Brenda Isbell**

**Tennessee Department of Education
Tennessee Department of Education**

**March 22, 2011
March 22, 2011**

IDEM, STEPHEN

Speaker in seminar: "Laboratory Testing of Saddle Tap Tees to Determine Loss Coefficients," SPIDA Meeting-AHR Expo, Las Vegas, NV, 2011. (The 2011 ASHRAE Winter Conference addressed the efficient use of energy, the greening of the industrial base, the real cost of zero-energy design and other topics related to design, standards, codes and professional skills.).

LE BORNE, SABINE

TTU chapter of Sigma Xi luncheon seminar on February 24, 2011. Purpose to "promote knowledge of ongoing campus research in the science and engineering areas".

SIRAJ, AMBAREEN

"Service Learning through Development of Computer Security Awareness and Training (CSAT) Seminar", *The 15h Colloquium for Information Systems Security Education (CISSE'11)*, Fairborn, OH, June 13-15, 2011.

STRETZ, HOLLY

Seminar for training on the Transmission Electron Microscope at MIMIC Facility at MTSU, Murfreesboro, Tennessee, August 2010.

GRADUATE THESIS/DISSERTATIONS AND OTHER STUDENT PUBLICATIONS**MASTERS****ABDULKADIR BEDIR**

Design of a Stand-Alone Control Strategy for Retrofit Hybrid Electric Vehicles
August 2010
Dr. Ali Alouani

GREGORY ALLEN BROWNING

Optimum Air Content Range in the Plastic and Hardened State for TDOT Class D Portland Cement Concrete
May 2011
Dr. L. K. Crouch

JEFFREY D. FOOTE

Effect of Hydrostatic Stress on Fracture Toughness for 2011-T3 Aluminum Notched Round Bars
December 2010
Dr. Christopher Wilson

NICHOLAS B. HODGES

Dynamic Frequency Estimation of PMU/FDR Measurements
May 2011
Dr. Ghadir Radman

JAIANAND JAYARAMAN

A Decentralized Approach to Energy Management and Conservation for Residential and Commercial Load
May 2011
Dr. Arun Sekar

RAHUL KAMBHAMPATI

Enhancement of Microgrid Dynamic Frequency Stability using Microgrid Frequency Controller (MGFC)
May 2011
Dr. Ghadir Radman

VENKATA SUDHIR BABU KARUSALA

New Implementations of Time-Reverse Precoders for UWB Communication Systems and Evaluation of Their Performance
December 2010
Dr. Periasamy K. Rajan

SANKET KHEDKAR

A Feasibility Study of a Wireless Strain Sensor for an Inkjet Printing Technology
August 2010
Dr. Stephen Parke and Dr. Hwan-Sik Yoon

ABOLI V. KULKARNI

Design and Optimization of Load Shedding Scheme in Power Systems
August 2010
Dr. Wenzhong Gao

ANURADHA KUMAR

Time Domain Spectroscopy Measurement on a Current Transformer
December 2010
Dr. Satish Mahajan

GRADUATE THESIS/DISSERTATIONS AND OTHER STUDENT PUBLICATIONS**MASTERS****AMIT LONARE**

Transfer Capacity Estimation using Extended DC-Model for Systems with Phase Shifting Transformers
August 2010
Dr. Ghadir Radman

STEVEN RICHARD MATHENEY

Freeze-Thaw Durability of Non-Air Entrained Concrete with Normal and Lightweight Aggregates
December 2010
Dr. Benjamin Mohr

MARTIN LUKE MEDLEY II

Pervious Concrete Mixture Design by the Unit Weight Method
December 2010
Dr. L. K. Crouch

BHARADWAJ PRABHALA

The Shape of a Sessile Drop
December 2010
Dr. Mahesh V. Panchagnula

KANAKADURGA PULIMERA

Independent Component Analysis for Harmonic Source Estimation with Piecewise Constant Parameter Mixed Measurements
December 2010
Dr. Periasamy K. Rajan

AMARNATH TAMERSI

Enhancement of Microgrid Dynamic Voltage Stability using Microgrid Voltage Stabilizer
May 2011
Dr. Ghadir Radman

VIVEKANAND S. TODAKAR

Reconfigurable Chip Design of Bidirectional Access Controller to the SD Card using FPGA
December 2010
Dr. Omar Elkeelany

ANDREW N. WATKINS

A Novel Control and Physical Realization of a Clean Hybrid Hydrogen Fuel-Cell/Battery Low-Power Personal Electric Vehicle
December 2010
Dr. Wenzhong Gao

VADIM ZHEGLOV

Double Input DC – DC Converter for Hybrid Electric Vehicles
August 2010
Dr. Wenzhong Gao

GRADUATE THESIS/DISSERTATIONS AND OTHER STUDENT PUBLICATIONS**PhD****JIAXIN NING**

Wide-Area Monitoring and Recognition for Power System Disturbances using Data Mining and Knowledge Discovery (DMKD) Theory
August 2010
Dr. Wenzhong Gao

NARAYANA PRASAD RAYAPATI

Eulerian Multiphase Model of Fragmenting Flows
August 2010
Dr. Mahesh Panchagnula and Dr. John Peddieson

GRADUATE STUDENT SUPPORT

SM-12

MS STUDENTS

Name	Dept.	Source of Support	Graduation Date	Advisor
Ahsan, Muhammad Nayeem	CEE	TDOT Traffic Signal Interchange	Summer 2011	Dr. Click
Balasubramanian, Srinath	ECE	CESR, ECE	Fall 2011	Dr. Mahajan
Browning, Gregory Allen	CEE	TDOT PCC AIR	Spring 2011	Dr. Crouch
Bryant, David Andrew	ME	NSF CCLI	Fall 2011	Dr. Canfield
Bryant, Lindsay	CEE	NSF Transport Kinetics, CEE	Fall 2011	Dr. Mohr
Bule, Mehari	ECE	ONR Winding Induction	Spring 2012	Dr. Ojo
Chaudhari, Ojas	CHE	CESR, CHE	Fall 2011	Dr. Biernacki
Crowley, Aaron	CEE	TDOT HVFA	Spring 2012	Dr. Crouch
Deaton, John	ECE	Buswell Energy, CESR, ECE	Fall 2011	Dr. Mahajan
Dillon, Sarah	CEE	CESR	Spring 2012	Dr. Crouch
Gautam, Amrit	ECE	ONR Winding Induction	Spring 2012	Dr. Ojo
Gokhale, Richa	ECE	CESR, ECE	Fall 2011	Dr. Mahajan
Halbrooks, David	ME	CESR	Summer 2012	Dr. Cui
Hill, Tristan	ME	NSF CCLI/TUES, RTT	Spring 2012	Dr. Canfield
Keaton, Daniel	CEE	NSF Ettringite	Spring 2012	Dr. Mohr
Kelley, Michael	CSC	NSF TUES	Fall 2013	Dr. Canfield
Kolluru, Lakshmi	ECE	CESR	Summer 2011	Dr. Radman
Kumar, Padmanabhan	ME	EIME Tennessee Department of Education	Spring 2012	Dr. Canfield
Lloyd, Travis	CEE	TDOT Traffic Signal Interchange	Summer 2011	Dr. Click
Longanecker, Landon	ECE	CESR, ECE	Fall 2011	Dr. Alouani
Matheny, Steven	CEE	NSF Transport Kinetics	Fall 2010	Dr. Mohr
McDaniel, Joseph Layton	CSC	CESR, CESR--DOE ORNL Smart Grid Research	Fall 2011	Dr. Siraj
Mihret, Melaku	ECE	ONR Winding Induction	Fall 2011	Dr. Ojo
Najafabadi, Amin	ECE	CESR	Summer 2012	Dr. Alouani
Pokharel, Bijaya	ECE	CESR, ECE	Fall 2011	Dr. Ojo
Rose, Ben	ECE	CESR, ECE	Fall 2011	Dr. Mahajan
Sontidpanya, Chayanon	ECE	CESR, ECE	Fall 2011	Dr. Radman
Zhang, Shuhai	CEE	TDOT Bridge Design	Spring 2012	Dr. Huo

PHD STUDENTS

Name	Dept.	Source of Support	Graduation Date	Advisor
Abounassif, Ahmed	ME	CESR	Summer 2012	Dr. Peddieson
Aganah, Kennedy	ECE	CESR, Office of Research	Fall 2012	Dr. Ojo
Aghazadeh Tabrizi, Mehriar	ECE	CESR	Spring 2012	Dr. Radman
Ambuken, Preejith	CHE	CESR	Summer 2013	Dr. Stretz
Jamehbozorg, Arash	ECE	CESR	Fall 2012	Dr. Radman
Jayanthi, Aditya	ME	CESR	Summer 2012	Dr. Peddieson/ Dr. Cui
Karimi-Davijani, Hossein	ECE	CESR, CESR--DOE ORNL Smart Grid Research	Fall 2012	Dr. Ojo
Keshmiri, Seyed Nassar	ECE	CESR, ORNL Smart Grid Research	Fall 2011	Dr. Radman
Kulkarni, Devendra	ME	CESR, ME	Fall 2011	Dr. Idem
Kumar, Ganapathy	ECE	CESR MOE	Spring 2012	Dr. Mahajan
Li, Xia	ECE	CESR, CMR	Summer 2014	Dr. Qiu
Ojo, Joshua	CEE	NSF Transport Kinetics	Spring 2012	Dr. Mohr
Stacy, Justin	ME	RTT	Spring 2012	Dr. Canfield
Zheng, Gang	ECE	CESR, CMR	Fall 2013	Dr. Radman

EIME Early Intervention and Mechanical Engineering (Tennessee State Department of Education)
 NSF National Science Foundation
 ONR Office of Naval Research
 ORNL/DOE Oak Ridge National Laboratory/Department of Energy
 RTT Robotic Technologies of Tennessee
 TDOT Tennessee Department of Transportation

HOURLY STUDENT PERSONNEL

SM-13

GRADUATE/UNDERGRADUATE STUDENTS

	MAJOR
Ahmed Abounassif	ME
Kennedy Aganah	EE
Mehriar Aghazadeh Tabrizi	EE
Onyinyechukwu Ahiakwo	EE
Preejith Ambuken	CHE
Joel Badoe	NURSING
Srinath Balasubramanian	EE
Matthew Bedford	MATH
Gregory A. Browning	CE
David A. Bryant	ME
Lindsay Smith Bryant	CE
Mehari Bule	EE
Uwakwe Chukwu	EE
Jordan Cleek	CE
Aaron Crowley	CE
John Deaton	EE
Erin DeCarlo	CE
Roland DeCicco	ME
Sarah Dillon	CE
Jeffrey Foote	ME
Amrit Gautam	EE
Steven Glandon	COMP ENGR
Richa Gokhale	EE
Jeff Graves	MATH
David Halbrooks	ME
Rabab Hassan	EE
John Hendrix	CE
Tristan Hill	ME
Joshua Hogancamp	CE
Michael Jordan Huddleston	ME
Arash Jamehbozorg	EE
Aditya Jayanthi	ME
Jaianand Jayaraman	EE
Samantha Jeffries	CE
Steven Jones	EE
Rahul Kambhampati	EE
Hossein Karimi-Davijani	EE
Sosthenes Karugaba	EE
Michael Kelley	CSC
Seyed Nasser Keshmiri	EE
Lakshmi Kolluru	EE
Devendra Kulkarni	ME

HOURLY STUDENT PERSONNEL

SM-13

GRADUATE/UNDERGRADUATE STUDENTS

	MAJOR
Anuradha Kumar	EE
Ganapathy Kumar	EE
Padmanabhan Kumar	ME
Amit Lonare	EE
Landon Longanecker	EE
Divya Mahabal	EE
Heather McCulloch	MATH
Joseph McDaniel	CSC
Emanuel Matee	EE
Will Mefford	EE
Melaku Mihret	EE
Amin Najafabadi	EE
Ananth Nalla	ME
David Nuckolls	CE
Joshua Ojo	CE
Shane Paulson	CE
Bijaya Pokharel	EE
Jeremy Prince	ME
Kanakadurga Pulimera	EE
Narayana Rayapati	ME
Erika Residori	MATH
Benjamin Rose	EE
Chayanon Sontidpanya	EE
Justin Stacy	ME
Andrew Starnes	MATH
Amarnath Tamersi	EE
Adam Thomas	EE
Sulayman Usman	EE
Enes Uzel	ME
Lazarus Uzoечи	EE
Samuel Wanjoeh	EE
Andrew Watkins	EE
Gang Zheng	EE
Work Study/Work Scholarship	
Benjamin Ellis	ME
Eric Ellis	ME
Steven Corum	ECE

BUDGET MATERIALS



Students conducting power electronics research into 3, 5 and, 7 phase generators and wind turbine emulators in Dr. Ojo's Power Laboratory (Photo courtesy CESR)

ACTUAL, PROPOSED, AND REQUESTED BUDGET

SCHEDULE 7

CENTERS OF EXCELLENCE/CENTERS OF EMPHASIS

	FY 2010-11 Actual			FY 2011-12 Proposed			FY 2012-13 Requested		
	Matching	Appopr.	Total	Matching	Appopr.	Total	Matching	Appopr.	Total
Expenditures	611,767	708,864	1,320,631	652,553	1,305,106	1,957,659	445,680	891,360	1,337,040
Salaries									
Faculty	165,787	27,814	193,601	117,146	117,100	234,246	79,962	86,470	166,432
Other Professional	14,340	214,557	228,897	200	292,050	292,250	2,850	296,230	299,080
Clerical/Supporting	3,911	21,661	25,572	2,369	62,600	64,969	1,550	56,290	57,840
Assistantships	150,091	213,809	363,900	121,686	232,259	353,945	97,060	125,000	222,060
Total Salaries	334,129	477,841	811,970	241,401	704,009	945,410	181,422	563,990	745,412
Fringe Benefits	44,043	74,695	118,738	19,118	165,800	184,918	18,421	173,680	192,101
Total Personnel	378,172	552,536	930,708	260,519	869,809	1,130,328	199,843	737,670	937,513
Non-Personnel									
Travel	20,684	10,986	31,670	13,134	48,000	61,134	18,227	28,690	46,917
Software	259	4,523	4,782	2,000	5,000	7,000	2,000	5,000	7,000
Books & Journals	199	307	506	500	2,000	2,500	2,000	2,000	4,000
Other Supplies	58,330	38,388	96,718	39,663	77,488	117,151	132,646	32,000	164,646
Equipment	0	0	0	0	138,500	138,500	0	5,000	5,000
Maintenance	2,348	0	2,348	2,000	1,000	3,000	0	1,000	1,000
Scholarships	72,650	93,691	166,341	54,870	155,809	210,679	38,685	80,000	118,685
Consultants	79,125	2,887	82,012	279,867	0	279,867	52,279	0	52,279
Renovation	0	0	0	0	0	0	0	0	0
Other (Advertising)	0	5,546	5,546	0	7,500	7,500	0	0	0
			0			0			0
			0			0			0
			0			0			0
Total Non-Personnel	233,595	156,328	389,923	392,034	435,297	827,331	245,837	153,690	399,527
GRAND TOTAL	611,767	708,864	1,320,631	652,553	1,305,106	1,957,659	445,680	891,360	1,337,040
Revenue									
New State Appropriation		896,700	896,700		865,400	865,400		891,360	891,360
Carryover State Appropriation		209,770	209,770		437,097	437,097		0	0
MOE Funds		26,100	26,100						
MOE Funds Carryover		16,000	16,000						
New Matching Funds	718,735		718,735	432,700		432,700	445,680		445,680
Previous Matching Funds	112,885		112,885	219,853	2,609	222,462			0
Total Revenue	831,620	1,148,570	1,980,190	652,553	1,305,106	1,957,659	445,680	891,360	1,337,040

SCHEDULE 13A

ACTUAL PERSONNEL

**TENNESSEE HIGHER EDUCATION COMMISSION
CENTERS OF EXCELLENCE
ACTUAL, 2010-2011**

Tennessee Technological University Center for Energy Systems Research June 30, 2011

a1. Faculty whose actual center effort will be at least 25% of full effort.

Name and Faculty Rank	Department Affiliation	Center Effort in %
Ali Alouani, Professor	Electrical and Computer Engineering	25
Steve Canfield,	Professor Mechanical Engineering	30
L. K. Crouch, Professor	Civil and Environmental Engineering	40
Omar Elkeelany, Associate Professor	Electrical and Computer Engineering	25
Sheikh Ghafoor, Assistant Professor	Computer Science	25
Stephen Idem, Professor	Mechanical Engineering	35
Sabine LeBorne, Associate Professor	Mathematics	30
Y. Jane Liu, Associate Professor	Civil and Environmental Engineering	25
Satish Mahajan, Professor	Electrical and Computer Engineering	40
Benjamin Mohr, Associate. Professor	Civil and Environmental Engineering	40
Sastry Munukutla, Professor	Mechanical Engineering	40
Joseph Ojo, Professor	Electrical and Computer Engineering	33
John Peddieson, Professor	Mechanical Engineering	30
Ghadir Radman, Professor	Electrical and Computer Engineering	45

***NOTE 1: Center faculty members** Number 14 FTE 4.63

a2. Faculty whose actual center effort will be less than 25% and all other personnel categories.

	Number	FTE
a. Faculty	12	1.33
b. Other Professionals	8	5.80
c. Clerical/Supporting	2	1.44
d. Assistantships	41	25.70
e. Hourly Students	75	7.70
TOTAL, all categories	152	46.60

SCHEDULE 13C**REQUESTED PERSONNEL****TENNESSEE HIGHER EDUCATION COMMISSION
CENTERS OF EXCELLENCE
REQUESTED, 2012-2013**

Tennessee Technological University

Center for Energy Systems Research

June 30, 2011

a1. Faculty whose actual center effort will be at least 25% of full effort.

Name and Faculty Rank	Department Affiliation	Center Effort in %
Steve Canfield, Professor	Mechanical Engineering	25
L. K. Crouch, Professor	Civil and Environmental Engineering	40
Sheikh Ghafoor, Assistant Professor	Computer Science	25
Stephen Idem, Professor	Mechanical Engineering	35
Y. Jane Liu, Associate Professor	Civil and Environmental	25
Satish Mahajan, Professor	Electrical and Computer Engineering	30
Benjamin Mohr, Associate Professor	Civil and Environmental Engineering	40
Joseph Ojo, Professor	Electrical and Computer Engineering	33
John Peddieson, Professor	Mechanical Engineering	30
Ghadir Radman, Professor	Electrical and Computer Engineering	25

NOTE 1: Center faculty members.*Number 10****FTE 3.08**

a2. Faculty whose actual center effort will be less than 25% and all other personnel categories.

	Number	FTE
a. Faculty	11	1.47
b. Other Professionals	4	4.00
c. Clerical/Supporting	2	2.00
d. Assistantships	40	25.00
e. Hourly Students	40	3.00
TOTAL, all categories	107	38.55

SCHEDULE 14A

2010-2011 PURCHASED EQUIPMENT

**TENNESSEE HIGHER EDUCATION COMMISSION
CENTERS OF EXCELLENCE
PURCHASED EQUIPMENT, 2010-2011**

INSTITUTION: Tennessee Technological University
CENTER OF EXCELLENCE: Energy Systems Research

DATE: June 30, 2011

State Appropriations

Description	Number	Unit Cost	Total
Subtotal, State Appropriations			\$0.00

Matching

Description	Number	Unit Cost	Total
Subtotal, Matching			\$0.00

GRAND TOTAL **\$0.00**

Grand Total	Matching	Appropriations
\$0.00	\$0.00	\$0.00

SCHEDULE 14B

PROPOSED EQUIPMENT

TENNESSEE HIGHER EDUCATION COMMISSION
CENTERS OF EXCELLENCE
PROPOSED EQUIPMENT, 2011-2012

INSTITUTION: Tennessee Technological University
CENTER OF EXCELLENCE: Energy Systems Research

DATE: June 30, 2011

State Appropriations

Description	Number	Unit Cost	Total
Network File Server (\$5,000 from 2011-2012 State Appropriations; \$7,500 from Carryforward from 2010-2011)	1	\$12,500	\$12,500
Research Laboratory Equipment Smart Grid Research, Power Systems Research, Renewal Energy Research, Transportation Research (From Carryforward from 2010-2011)	1	\$126,000	\$126,000
Subtotal, State Appropriations			\$138,500

Matching

Description	Number Total	Unit Cost
Subtotal, Matching		\$0
GRAND TOTAL		\$138,500

Grand Total	Matching	Appropriations
\$138,500	\$0	\$138,500

SCHEDULE 14C**REQUESTED EQUIPMENT**

TENNESSEE HIGHER EDUCATION COMMISSION
CENTERS OF EXCELLENCE
REQUESTED EQUIPMENT, 2012-2013

INSTITUTION: Tennessee Technological University
CENTER OF EXCELLENCE: Energy Systems Research

DATE: June 30, 2011

State Appropriations

Description	Number	Unit Cost	Total
Research Laboratory Equipment	1	\$5,000	\$5,000
Subtotal, State Appropriations			\$5,000

Matching

Description	Number	Unit Cost	Total
Subtotal, Matching			\$0.00

GRAND TOTAL **\$5,000**

Grand Total	Matching	Appropriations
\$5,000	\$0.00	\$5,000

SCHEDULE 15A
BASE SUPPORT AND NON-EQUIPMENT MATCHING

ACTUAL 2010-2011

Budget Account Numbers	2010-2011 Actual Expenditures
2-10406, 2-10407, 2-10409, 2-10436, 2-10437, 2-10438, 2-10411, 2-10412, 2-10413, 2-10108, 2-10499, 2-10416, 2-10417, 2-10418, 2-10421, 2-10423, 2-10431, 201432, 2-10426, 2-10427, 2-10428, 2-10460, 2-45016, 2-29144	9,599,748
TOTAL BASE SUPPORT	9,599,748

**Non-Equipment Matching
 Restricted Accounts
 (No equipment or indirect costs included)**

Account Number	Project Title and Sponsor	Amount
539234	Advanced Systems Development of the MRWS: a Remote Climbing Robot for Automating Welding Processes in the Ship Building Industry (National Shipbuilding Research Program)	17,212
539275	Simplified Live Load Distribution Factor Equations for Tennessee Highway Bridge Design - Federal (Year 2 of 2) (Tennessee Department of Transportation)	22,610
539276	Simplified Live Load Distribution Factor Equations for Tennessee Highway Bridge Design - State (Year 2 of 2) (Tennessee Department of Transportation)	5,652
539277	Optimum Air Content Range (Plastic and Hardened) for TDOT Class D Portland Cement Concrete (PCC) - State (Year 2 of 3) (Tennessee Department of Transportation)	8,696
539274	Optimum Air Content Range (Plastic and Hardened) for TDOT Class D Portland Cement Concrete (PCC) - Federal (Year 2 of 3) (Tennessee Department of Transportation)	34,782
531216	Nanoscale Characterization of Expansion Due to Delayed Ettringite Formation (National Science Foundation)	54,277
532344	Performance Optimization and Extended Speed Control of Multi-Phase Winding Induction (Office of Naval Research)	55,691
536229	Evaluation of Low-Cost Digital Image Correlation for Strength Tests (United Launch Alliance)	14,408

SCHEDULE 15A**BASE SUPPORT AND NON-EQUIPMENT MATCHING****Non-Equipment Matching
Unrestricted Matching
(No equipment or indirect costs included)**

Account Number	Project Title and Sponsor	Amount
531651	Algebraic Hierarchical Matrix Preconditioners for Two- and Three-Dimensional Saddle Point Problems (National Science Foundation)	36,520
539510	Enabling Children with Disabilities and Their Families in Tennessee through Technology EIME Project - Preschool (Year 2 of 3) (State Department of Education - Division of Special Education)	25,926
539511	Enabling Children with Disabilities and Their Families in Tennessee through Technology EIME Project - School Age (Year 2 of 3) (State Department of Education - Division of Special Education)	6,481
539322	Development of Tennessee Travel Demand Model Users' Group (Year 1 of 3) (University of Tennessee-Knoxville - Funded by the Tennessee Department of Transportation)	7,826
539322	Development of Tennessee Travel Demand Model Users' Group (Year 2 of 3) (University of Tennessee-Knoxville - Funded by the Tennessee Department of Transportation)	8,043
533216	Field Evaluation of Traffic Signal Based Interchange Treatments - State (Year 2 of 3) (Tennessee Department of Transportation)	11,652
539278	Field Evaluation of Traffic Signal Based Interchange Treatments - Federal (Year 2 of 3) (Tennessee Department of Transportation)	46,609
539279	Higher Volume Fly Ash PCC for Sustainability and Performance - Federal (Year 1 of 2) (Tennessee Department of Transportation)	45,218
539280	Higher Volume Fly Ash PCC for Sustainability and Performance - State (Year 1 of 2) (Tennessee Department of Transportation)	11,304
531258	Enhancing the Programming Experience for Engineering Students through Hands-On Integrated Computer Experiences: Phase II (Year 1 of 3) (National Science Foundation)	177,984

SCHEDULE 15A**BASE SUPPORT AND NON-EQUIPMENT MATCHING**

**Non-Equipment Matching
Unrestricted Matching
(No equipment or indirect costs included)**

Account Number	Project Title and Sponsor	Amount
535219	Using Solar Power for Chevy Volts Commuters: Feasibility Study	11,686
531652	CAREER: Wind Power - Multi-Level Control, Intelligent Grid Integration and Real Time Digital Simulation (Year 2 of 5) (National Science Foundation)	70,125
536230	Large Strain Behavior of Rohacell (United Launch Alliance)	14,337
538597	Power-Test-Service Account	11,266
Subtotal, Restricted Accounts		698,305

**Unrestricted Matching
(No equipment or indirect costs included)**

Account Number		Amount
229342	TTU Research	13,410
229638	Gao IC Faculty Energy Systems Research	-
229660	Munukutla IC Faculty Energy Systems Research	7,020
Subtotal, Unrestricted Accounts		20,430

**Other Matching
(Gifts and other non-equipment support not having account numbers)**

1.	TVA Upperclassman Scholarship	0
2.	Excellence in Electric Power Scholarship	0
3.	Carryover Match, Operations, 2009-2010	112,885
Subtotal, Other Matching		\$112,885
TOTAL, NON-EQUIPMENT MATCHING		\$831,620

SCHEDULE 15B

PROPOSED BASE SUPPORT AND NON-EQUIPMENT MATCHING

**BASE SUPPORT AND NON-EQUIPMENT MATCHING
PROPOSED, 2011-2012**

**2011-2012
Proposed Expenditures**

Budget Account Numbers

2-10406, 2-10407, 2-10409, 2-10436, 2-10437, 2-10438,
2-10411, 2-10412, 2-10413, 2-10108, 2-10499, 2-10416,
2-10417, 2-10418, 2-10421, 2-10423, 2-10431, 2-10432,
2-10426, 2-10427, 2-10428, 2-10460, 2-45016, 2-29144

9,887,740

TOTAL BASE SUPPORT

9,887,740

Non-Equipment Matching

Restricted Accounts

(No equipment or indirect costs included)

- | | |
|--|---------|
| 1. National Science Foundation (NSF) | 330,625 |
| 2. Tennessee Department of Transportation | 49,918 |
| 3. Tennessee State Department of Education | 32,407 |

Subtotal, Restricted Accounts

412,950

Unrestricted Accounts

**Account
Number**

Amount

TTU Research 19,750

Subtotal, Unrestricted Accounts

19,750

TOTAL, NON-EQUIPMENT MATCHING

432,700

SCHEDULE 15C

BASE SUPPORT AND NON-EQUIPMENT MATCHING

**BASE SUPPORT AND NON-EQUIPMENT MATCHING
REQUESTED, 2012-2013**

**2012-2013
Proposed Expenditures**

Budget Account Numbers

2-10406, 2-10407, 2-10409, 2-10436, 2-10437, 2-10438,
2-10411, 2-10412, 2-10413, 2-10108, 2-10499, 2-10416,
2-10417, 2-10418, 2-10421, 2-10423, 2-10431, 2-10432,
2-10426, 2-10427, 2-10428, 2-10460, 2-45016, 2-29144

TOTAL BASE SUPPORT **10,184,372**

Non-Equipment Matching
Restricted Accounts
(No equipment or indirect costs included)

- | | | |
|----|--|---------|
| 1. | National Science Foundation (NSF) | 348,723 |
| 2. | Tennessee Department of Transportation | 84,107 |
| 3. | Power-Test-Service Account | 6,000 |

Subtotal, Restricted Accounts **438,830**

Unrestricted Accounts

Account Number	Amount
TTU Research	6,850
Subtotal, Unrestricted Accounts	6,850

TOTAL, NON-EQUIPMENT MATCHING **445,680**

Center for Energy Systems Research

1020 Stadium Drive, Prescott Hall 414

P.O. Box 5032

Cookeville, TN 38505

Phone (931) 372-3615

www.cesr.tntech.edu/

Center Interim Director: Subramaniam Deivanayagam

Special thanks go to Linda Lee, Etter Staggs, our Faculty and Faculty Associates for their assistance in the content of this report.

August 2011

Tennessee Tech University

A Constituent University of the Tennessee Board of Regents is an

AA/EEO/Title IX/Section 504/ADA University.